

**ARINC SPECIFICATION 858 PART 3  
TABLE OF CONTENTS**

1.0	INTRODUCTION.....	1
1.1	Purpose.....	1
1.2	Scope.....	1
1.3	Document Overview.....	1
1.3.1	Multi-Part Specification Organization.....	1
1.3.2	Part 1 Document Organization.....	1
1.4	Related Documents.....	2
1.4.1	Relationship of this Document to Other ARINC Standards.....	2
1.4.2	Relationship to Other Industry Standards.....	3
1.5	Regulatory Approval.....	4
2.0	CIRI PROTOCOL DESCRIPTION.....	5
2.1	Use Case.....	5
2.2	Functional Description.....	6
2.3	Interface Description.....	7
2.4	Basic Communication Patterns.....	8
2.4.1	Control Plane.....	8
2.4.2	Data Plane.....	9
2.5	Flow Control Mechanism Description.....	10
2.6	Airborne Radio Reference Model.....	11
3.0	CIRI PROTOCOL MESSAGE STRUCTURE.....	13
3.1	Message Format.....	13
3.2	Option Format.....	13
3.3	Message Option Specification.....	14
3.3.1	Datalink Identifier Option.....	14
3.3.2	Link Instance Option.....	15
3.3.3	Datalink Context Option.....	16
3.3.4	Channel Status Option.....	16
3.3.5	Flow Sequence Option.....	17
3.3.6	Flow Window Option.....	18
3.3.7	Packet Data Option.....	19
3.3.8	Channel Identifier Option.....	19
3.3.9	Expiration Time Option.....	20
4.0	CIRI PROTOCOL OPERATION.....	21
4.1	Transport Requirements.....	21
4.2	Channels.....	21
4.3	Airborne IPS System Endpoint Operation.....	22
4.3.1	Configuration.....	22
4.3.2	Control Plane Operation.....	24
4.3.2.1	CIRI Control Plane Message.....	25
4.3.3	Status Processing.....	25
4.3.4	Data Plane Operation.....	25
4.3.4.1	CIRI Data Plane Message.....	26
4.4	Airborne Radio Endpoint Operation.....	26
4.4.1	Configuration.....	26
4.4.2	Control Plane Operation.....	27
4.4.2.1	CIRI Control Plane Message.....	28
4.4.3	Data Plane Operation.....	28
4.4.3.1	CIRI Data Plane Message.....	28
4.5	Flow Control.....	29
4.5.1	Airborne IPS System Flow Control Operation.....	29

**ARINC SPECIFICATION 858 PART 3  
TABLE OF CONTENTS**

4.5.2	Airborne Radio Flow Control Operation .....	31
4.5.3	Flow Control Example.....	32
ATTACHMENT 1 LIST OF ACRONYMS .....		34
ATTACHMENT 2 GLOSSARY.....		36
APPENDIX A CIRI PROTOCOL BACKGROUND.....		40
A-1	Common IPS Radio Interface Requirements.....	40
A-2	Protocol Design Principles.....	43
A-3	Candidate Protocol Alternatives – Initial Assessment .....	44
A-3.1	Custom Layer 2 Protocol .....	44
A-3.2	SNMP .....	44
A-3.3	ARINC 839 MAGIC.....	45
A-3.4	TCP-based Data Plane Protocol.....	45
A-3.5	Custom UDP-based Protocol – Common IPS Radio Interface Protocol (CIRI).....	45
A-3.6	Candidate Protocol Summary .....	46
A-4	Candidate Protocol Alternatives – Secondary Assessment .....	46
A-4.1	Comparison Overview .....	47
A-4.2	DLEP Profile for the Common IPS Radio Interface .....	47
A-4.2.1	Signaling Datalink Status (Requirements 1 and 2) .....	47
A-4.2.2	Signaling Status for Multiple Datalink Channels (Requirement 3).....	48
A-4.2.2.1	Option 1: Separate DLEP Sessions.....	48
A-4.2.2.2	Option 2: Abusing DLEP Destinations .....	48
A-4.2.2.3	Option 3: Custom DLEP Extension.....	48
A-4.2.3	Reporting Auxiliary Information (Requirement 4).....	48
A-4.2.4	Data Plane (Requirements 5 and 6).....	48
A-4.2.5	Flow Control (Requirements 7, 8, and 9).....	48
A-4.2.6	Robustness (Requirements 10, 11, 12, and 13) .....	49
A-4.2.7	General Operation (Requirements 14 and 15).....	49
A-4.3	DLEP Comparison Summary.....	49

## 1.0 INTRODUCTION

### 1.0 INTRODUCTION

#### 1.1 Purpose

As described in ARINC 858 Part 1, the Airborne IPS System must provide a datalink adaptation function to accommodate existing radio-specific interfaces. Although it is well understood that these radio-specific interface specifications are well-established in the respective radio standards, it is envisioned that some of these standards will be updated to accommodate the addition of IPS services. As these updates occur, there is an opportunity to harmonize the radio interface protocol and minimize the need for radio-specific adaptations in the Airborne IPS System.

The Common IPS Radio Interface (CIRI) protocol specified in this standard is intended to facilitate this harmonization by providing a standardized means to exchange status and information in a manner that allows different radios to assess/present link status and to handle the flow of information consistent with the radio's abilities. Therefore, the CIRI protocol should be adopted, by reference to this standard, as the radio standards are updated.

Commented [OML1]: Ed. Note – Text formerly in Section 2.2 (prior to re-org)

#### 1.2 Scope

This document serves as an ARINC standard to define a Common IPS Radio Interface (CIRI) protocol for conveying radio status information and for transferring digital data between the Airborne IPS System and Airborne Radios. This standard includes the functional description of the protocol including applicable use cases, protocol message formats, and protocol operation for both control plane and data plane exchanges. The protocol is intended to operate over a variety of on-aircraft communication means including, but not limited to, ethernet-based and ARINC 664-based aircraft networks.

### 1.3 Document Overview

#### 1.3.1 Multi-Part Specification Organization

ARINC 858 is published as a multi-part document specification that includes the following documents:

- Part 1 – Airborne IPS System Technical Requirements
- Part 2 – IPS Gateway Air-Ground Interoperability
- Part 3 (*this document*) – Common IPS Radio Interface (CIRI) Protocol

#### 1.3.2 Part 1 Document Organization

This document is organized as follows:

- Section 1.0 – Introduction  
This section introduces the purpose and scope of this document, identifies related reference documents, and provides guidance for regulatory compliance.
- Section 2.0 – CIRI Protocol Description  
This section provides an overview of the protocol use case, and it describes the protocol functions, interfaces, basic communication patterns for control-plane and data-plane message exchanges, and flow control mechanism.

**1.0 INTRODUCTION**

- Section 3.0 – CIRI Protocol Message Structure  
This section defines the CIRI protocol message format and the format and content of message options.
- Section 4.0 – CIRI Protocol Operation  
This section describes the transport mechanism requirements, how datalink channels are used, configuration of the Airborne IPS System and Airborne Radio CIRI endpoint, and the CIRI protocol operation for the exchange of control-plane messages and data-plane messages.
- Attachment 1 – List of Acronyms  
This attachment provides a list of acronyms used in this document.
- Attachment 2 – Glossary  
This attachment explains the precise meaning of terms used in this document to avoid ambiguity and confusion.
- Appendix A – CIRI Protocol Background  
This appendix provides background information that explains the basis for the selection and characteristics of the CIRI protocol defined in the main body of this specification.

To assist readers with navigating this document, the following figure is an illustrative guide to the document sections and the relationships among the sections.

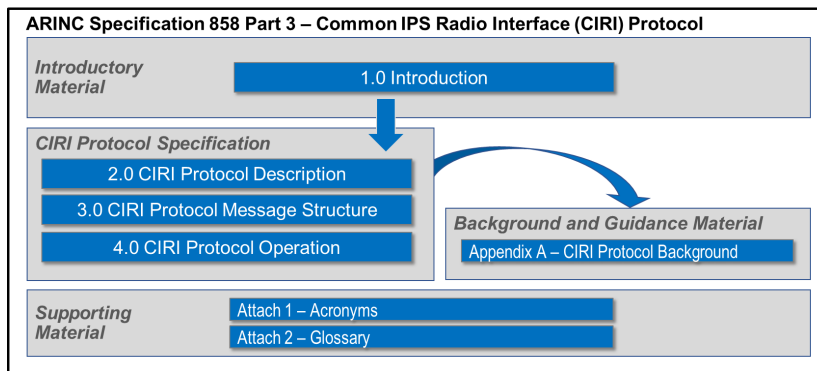

**Figure 1-1 – Guide to ARINC Specification 858 Part 3**

**1.4 Related Documents**

When avionics systems and subsystems are designed to use the capabilities provided by this specification, they should incorporate the provisions of this specification by reference. References to this specification should assume the application of the latest applicable version.

**1.4.1 Relationship of this Document to Other ARINC Standards**

ARINC Standards related to this specification are listed below, and the reader should ascertain the latest applicable published version.

**ARINC Specification 429:** *Digital Information Transfer System (DITS)*

**ARINC Specification 664:** *Aircraft Data Network*

## 1.0 INTRODUCTION

**ARINC Characteristic 750:** *VHF Data Radio*

**ARINC Characteristic 763A:** *Mark 2 Network Server System (NSS) Form and Fit Definition*

**ARINC Characteristic 766:** *Aeronautical Mobile Airport Communication System (AeroMACS) Transceiver and Aircraft Installation Standards*

**ARINC Characteristic 771:** *Low-Earth orbiting Aviation Satellite Communication System*

**ARINC Characteristic 781:** *Mark 3 Aviation Satellite Communication System*

**ARINC Characteristic 791:** *Mark 1 Aviation Ku-band and Ka-band Satellite Communication System*

**ARINC Characteristic 792:** *Second-Generation Ku-band and Ka-band Satellite Communication System*

**ARINC Specification 822A:** *On-ground Aircraft Wireless Communication*

**ARINC Specification 839:** *Function Definition of Airborne Manager of Air-Ground Interface Communications (MAGIC)*

**ARINC Specification 858:** *Internet Protocol Suite (IPS) for Aeronautical Safety Services, Part 1, Airborne IPS System Technical Requirements*

### 1.4.2 Relationship to Other Industry Standards

The following list identifies related industry documentation referenced in this document. The version cited was available at the time of this writing, and the reader should ascertain the latest applicable published version.

#### EUROCAE

- **ED-262A:** *Technical Standard of Aviation Profiles for Internet Protocol Suite.* Also published as RTCA DO-379A.

#### International Civil Aviation Organization (ICAO)

- **ICAO Doc. 9896 Ed. 3:** *Manual for the Aeronautical Telecommunication Network (ATN) using Internet Protocol Suite (IPS) Standards and Protocols*

#### Institute of Electrical and Electronics Engineers (IEEE)

- **IEEE 802.21-2008:** *IEEE Standard for Local and Metropolitan Area Networks - Part 21: Media Independent Handover Services*

#### Internet Engineering Task Force (IETF)

Note: Rather than referencing all IETF Request For Comments (RFCs) directly, this document refers to EUROCAE ED-262A and RTCA DO-379A, Internet Protocol Suite Profiles, which reference IETF RFCs relevant to specification of the IPS network stack. This approach minimizes changes to this document as IETF RFCs evolve over time.

- **RFC 1982:** *Serial Number Arithmetic*
- **RFC 8175:** *Dynamic Link Exchange Protocol (DLEP).*
- **RFC 8651:** *Dynamic Link Exchange Protocol (DLEP) Control-Plane-Based Pause Extension*

## 1.0 INTRODUCTION

- **RFC 8703:** Dynamic Link Exchange Protocol (DLEP) Link Identifier Extension

### RTCA

- **DO-379A:** Technical Standard of *Aviation Profiles for Internet Protocol Suite*. Also published as EUROCAE ED-262A.

### Single European Sky Air Traffic Management Research Joint Undertaking (SESAR JU)

- **[FCI-FRD]:** Future Communications Infrastructure (FCI) Functional Requirements Document (FRD), SESAR2020 PJ14-02-04 deliverable D5.2.010, Edition 00.00.07, 2018.

## 1.5 Regulatory Approval

This standard, in and of itself, will not ensure regulatory approval. Implementers are urged to obtain all information necessary for regulatory approval and work in close coordination with the appropriate regulatory authorities to gain certification as applicable.

2.0 CIRI PROTOCOL DESCRIPTION

2.0 CIRI PROTOCOL DESCRIPTION

2.1 Use Case

Existing Airborne Radios that are candidates to support IPS present a variety of radio-specific interface definitions with little-to-no commonality. Having heterogeneous Airborne Radio interfaces creates a diverse environment where the Airborne IPS System must adapt to the various radio-specific interfaces, each of which do not provide the same information or capabilities.

The CIRI protocol provides a unified and extensible way of interfacing the Airborne IPS System with IPS-enabled Airborne Radios to support the needs of IPS, particularly in terms of multilink and Quality of Service (QoS). As illustrated in Figure 2-1, and accordance with the interface labeling conventions used in Section 3.7 of ARINC 858 Part 1, the CIRI protocol implements the Airborne IPS System external interface IF-4C, which handles data flows to and from IPS-enabled Airborne Radios, as well as radio status signaling to the Airborne IPS System.

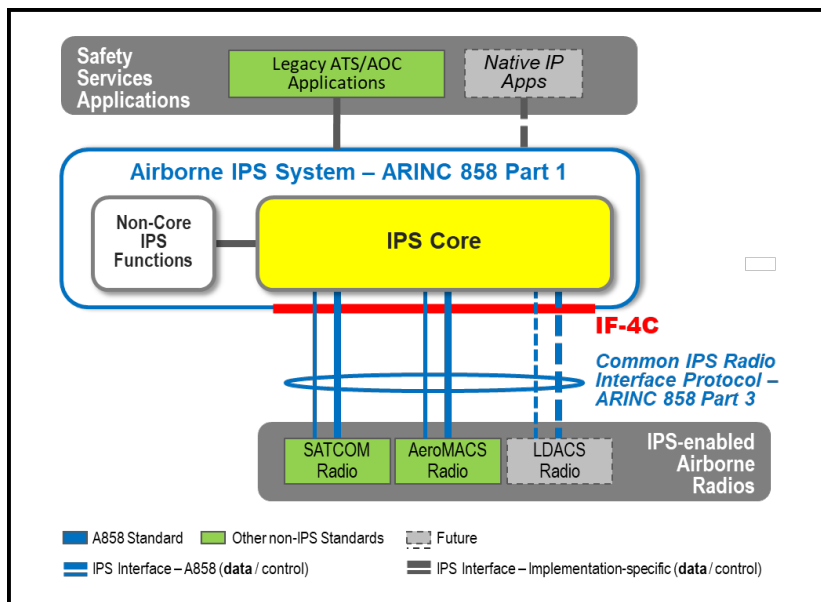

Figure 2-1 – Common IPS Radio Interface

As shown in the figure and summarized in the following table, the CIRI protocol specifically targets IPS-enabled Airborne Radios; throughout this document, instances of Airborne Radio should be interpreted as meaning IPS-enabled Airborne Radio.

2.0 CIRI PROTOCOL DESCRIPTION

Table 2-1 – Common IPS Radio Interface **Applicability**

Airborne Radio			Airborne IPS System	
			Radio-specific Adaptation	Common IPS Radio Interface
Legacy (non-IP) Radio	VDR	A750	Yes [1]	No [2]
IPS-enabled Radio	AeroMACS	A766	Yes [1]	Optional [3]
	LDACS	<i>Future</i>	<i>TBD [4]</i>	<i>TBD [4]</i>
	Certus	A771	Yes [1]	Optional [3]
	SB-Safety	A781	Yes [1]	Optional [3]
IP-enabled Radio	Gatelink WiFi	A763A / A822A	Out of scope of ARINC 858 [5]	
	Gatelink Cellular			
	Air-to-Ground Cellular	N/A		
	Ku / Ka SATCOM	A791 / A792		

Notes:

- For existing radios that do not implement the CIRI protocol, the Airborne IPS System provides adaptation of radio-specific interfaces.
- Although the CIRI protocol is not intended for implementation in legacy radios such as a VDR, it may be used as the interface between IPS functions and VDLm2 link layer functions internal to the system (e.g., Airborne IPS System) that implements these functions.
- The standards for IPS-enabled radios may be updated to specify the Common IPS Radio Interface Protocol in lieu of or in addition to existing radio-specific **control plane and data plane** interfaces.
- When a future LDACS standard is developed, the radio **control plane and data plane** interfaces with the Airborne IPS System may be specified as the Common IPS Radio Interface Protocol, in which case radio-specific adaptation would not be required.
- The Airborne IPS System is not expected to interface directly with IP-enabled radios in the Aircraft Information Services Domain (AISD) but rather with an intermediary device (e.g., an AISD router or an Aircraft Interface Device (AID)) that interfaces with the IP-enabled radios. As noted in ARINC 858 Part 1, Section 2, implementation of a cross-domain interface is aircraft architecture-dependent and out of scope of A858.

**Commented [OML2]:** Ed. Note: The table below is inserted as picture since the textual table was misbehaving. To be fixed later.

2.2 Functional Description

The CIRI protocol is designed for exchanging information between Airborne IPS System and IPS-enabled Airborne Radio via the on-aircraft communication means described in Section 2.3. The CIRI protocol supports the exchange of two message types: control-plane messages and data-plane messages.

The main functions provided by CIRI are summarized in the following bullets:

- Radio Status Signaling – Basic function that uses control-plane CIRI messages to provide the Airborne IPS System with up-to-date information about the status of datalink channels provided by onboard Airborne Radios. While this status information must include at least an indication of whether the datalink is operational (i.e., able to deliver data-plane packets to the ground), the protocol supports the exchange of additional detail (if available from the radio) that allows the Airborne IPS System to make more informed link decisions and ensure QoS of the communication.

**Commented [FW3]:** It would be good to say functions are out of scope for CIRI, for example:

- Enabling/disabling radio
- Scanning for available ground infrastructure
- Establishing/disconnecting A/G link
- Applying A/G link specific parameters (e.g. modulation)
- and similar

It could be indicated that device (or technology) specific protocols are used for the above functions.

In other words, I am looking for a clear statement what CIRI is not.

**Commented [FW4R3]:** I can see that there is a note about that in “3.1.1 Control Plane”, but IMHO this deserves explicit statements.

**Commented [JZ5R3]:** A note added at the bottom of the section



2.0 CIRI PROTOCOL DESCRIPTION

- Data Packet Exchange – Optional function that uses data-plane CIRI messages to exchange of air-to-ground and ground-to-air IPv6 packets between the Airborne IPS System and the Airborne Radio. The air-to-ground, and possibly the ground-to-air, packets could be associated with some metadata, for example to differentiate among packets with different QoS needs or indicate whether the packet is subject to Required Communication Performance (RCP) requirements.
- Flow Control – Optional function that uses both control-plane and data-plane CIRI messages to enable throttling of the flow of the air-to-ground packets contained in data-plane messages sent from the Airborne IPS System to the Airborne Radio. Flow control ensures that at any given time, only a bounded amount of air-to-ground data is queued for transmission in the Airborne Radio and the remaining data can be queued in the Airborne IPS System.

Note that the CIRI protocol does not provide any functions for controlling the Airborne Radios (e.g., enabling/disabling a radio, frequency tuning, mode/modulation selection, etc.). These radio control functions are provided by a radio-specific interface and protocol, which are out of the scope of this specification.

Commented [FW6]: I would say that "could be" is more appropriate.

Commented [FW7]: I can see later in the text that these messages belong to Control Plane (or at least it is implied). Maybe these bullets could be rewritten in such a way that the Flow Control is a part of Control Plane?

Commented [JZ8R7]: The flow control is a function (not a third "message type") that is implemented by combination of control plane and data plane CIRI messages, see the updated text.

Note: because of relative complexity and uncertain benefits of the flow control, I tried to describe it in the document as separately as possible (so the reader can read the document "without flow control"; this consideration applies mainly to section 5.5)

2.3 Interface Description

The CIRI protocol is designed to support a variety of on-board communication means, including Ethernet-based and ARINC 664-based aircraft networks, which are envisioned to be the future onboard network solutions when IPS is deployed.

As illustrated in Figure 2-2, the CIRI protocol may use any on-aircraft communication means where the transport mechanism meets the requirements specified in Section 4.1.

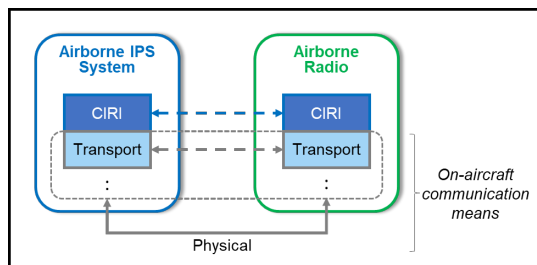

Figure 2-2 – Notional CIRI Protocol Context

Figure 2-3 illustrates an example protocol stack, where the on-aircraft communication means uses UDP/IPv4 over ethernet, which is representative of the onboard networks expected to be used when IPS is deployed.

Commented [SM9]: [P3-M22-01 – M.Skorepa/Z.Jaron-HON]: Clarify the diagram to indicate that it is an example, or abstract the diagram.

Commented [OML10R9]: M23 – Fig 2-2 is abstracted; Fig 2-3 is example.

2.0 CIRI PROTOCOL DESCRIPTION

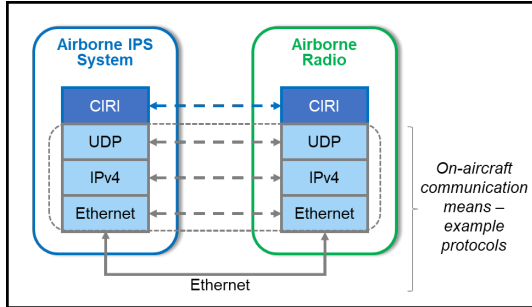

Figure 2-3 – Representative CIRI Protocol Context Example

2.4 Basic Communication Patterns

2.4.1 Control Plane

The primary purpose of the CIRI protocol is for an Airborne Radio to provide various status information to the Airborne IPS System. In the simplest variant, the radio endpoint provides only discrete status for one or more datalink channels (see Section 3.3.4), but the CIRI protocol provides structures to convey other information as well. All CIRI messages contain a Datalink Identifier option that uniquely identifies each individual Airborne Radio CIRI endpoint in the scope of the aircraft.

COMMENTARY

As noted previously in Section 2.2, the CIRI protocol is not intended to provide the Airborne IPS System with the capabilities to control the Airborne Radios (e.g., enabling/disabling the radio, frequency tuning, etc.).

The basic control plane communication pattern is illustrated in Figure 2-4.

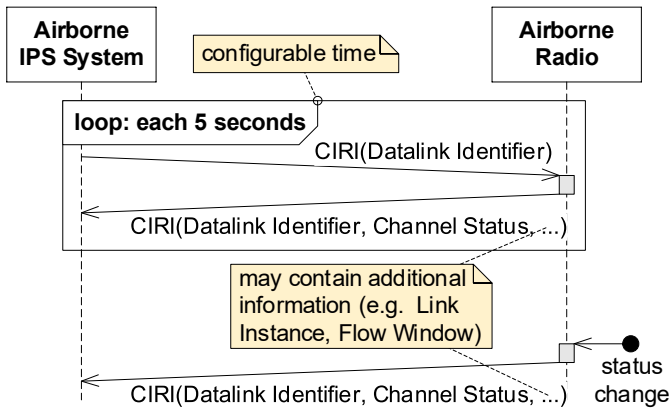

Figure 2-4 – Basic Control Plane Communication Pattern

2.0 CIRI PROTOCOL DESCRIPTION

The Airborne IPS System periodically sends a control-plane CIRI message to query the status of the Airborne Radio channels, and the Airborne Radio replies with control-plane CIRI message that includes Channel Status, and optionally other information. These messages also serve as a health monitoring of the Airborne Radio. Additionally, the radio sends an unsolicited control-plane CIRI message whenever a datalink channel status changes. See Section 4.0 for details.

This protocol does not provide any means for the Airborne IPS System to dynamically “request” or to “subscribe to” any particular information from the Airborne Radio. It is assumed that the Airborne Radio is statically configured with regard to what kind of information is provided to the Airborne IPS System.

It is also expected that different radios in an aircraft will be able to provide different types of information. The Airborne IPS System should be able to cope with this, for example by static configuration of what information is expected from which radio. This document does not describe how is this information processed in the Airborne IPS System in much detail, as this is deemed to be a local implementation detail with little impact on interoperability.

**Commented [FW11]:** Added this to show the purpose of the periodic control plane message. Please remove if you consider that this is unnecessary.

**Commented [JZ12R11]:** accepted

**Commented [FW13]:** Configuration parameter: the content of the status message from Airborne radio (what’s possible, what is the minimum required information).

Configuration parameter: status query interval

Question: Is the status query limited to a single link\_id, or many link\_ids can be queried in a single message. Assumption: it’s the second case (because why not?).

**Commented [JZ14R13]:** Section 5.4.1 now describes the configuration of services in the Radio

“status query interval” is the HelloTime described in section 5.3.1 for the Airborne IPS System (the radio does not need any timers for CIRI operation)

One CIRI message can handle information about one datalink ID only. If one radio provides multiple separate “datalinks”, then each of them needs a dedicated “CIRI endpoint” (and the CIRI messages can be demultiplexed by contents of the Datalink Identifier option)

**Commented [FW15]:** Suggestion: “i.e.,” (that is)

**Commented [JZ16R15]:** The CIRI does not care about what kind of packets is carried. But I take it that admitting this degree of freedom in the context of IPS might be confusing.

**Commented [FW17]:** This could be moved to the message specification part.

**Commented [JZ18R17]:** done

2.4.2 Data Plane

Optionally, the CIRI protocol may also be used to carry the data-plane communication between Airborne IPS System and the Airborne Radio, in one or both directions. If enabled, the data-plane packets (i.e., IPv6 packets) are carried by data-plane CIRI messages in a Packet Data option. The basic data plane communication pattern is illustrated in Figure 2-5.

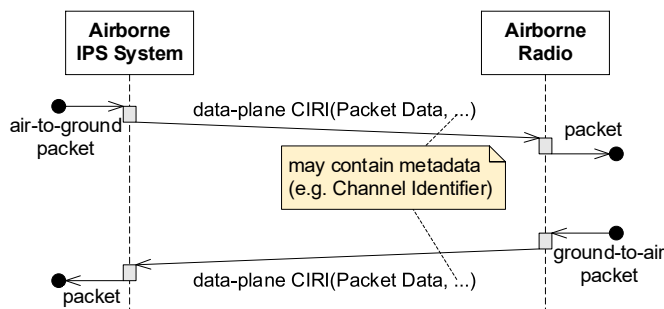

Figure 2-5 – Data Plane Communication Pattern

COMMENTARY

The CIRI protocol data plane communication is provided primarily to facilitate attaching metadata, such as Channel Identifier, to air-to-ground packets, but it is not required for the control-plane CIRI operation. The Airborne Radio may gather all necessary information by other means; for example, a datalink providing two channels might use two independent plain data interfaces (e.g., two dedicated physical interfaces) to discriminate between packets of these channels.

2.0 CIRI PROTOCOL DESCRIPTION

2.5 Flow Control Mechanism Description

The CIRI protocol includes a flow control mechanism, which provides the ability to throttle the flow of packets from the Airborne IPS System to the Airborne Radio when data-plane CIRI messages are used to exchange data-plane communications. A flow is a datalink channel that is flow controlled. The CIRI protocol can support flow control for zero or more datalink channels (see Section 4.2).

An example flow control sequence, which uses a combination of control-plane and data-plane CIRI messages, is illustrated in Figure 2-6.

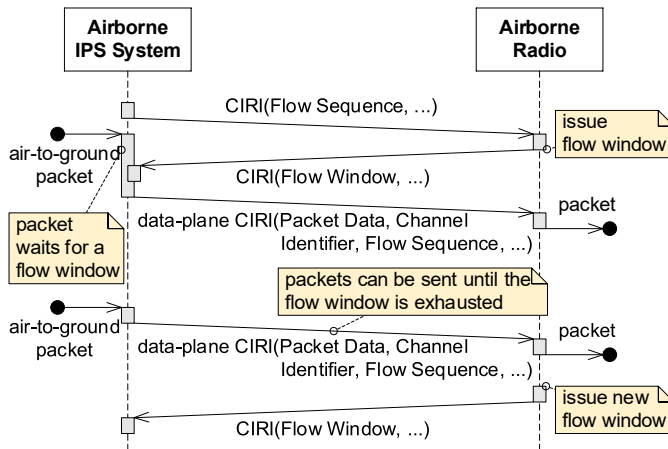

Figure 2-6 – Flow Control Example Sequence

For a flow-controlled datalink channel, the flow control mechanism can be summarized as follows:

- Using a control-plane CIRI message, the Airborne IPS System announces an arbitrary initial *Flow Sequence* value. The *Flow Sequence* is used as a counter of bytes sent within the flow-controlled datalink channel.
- Using a control-plane CIRI message, the Airborne Radio can then issue a *Flow Window*, specifying a number of bytes that can be accepted by the radio in the datalink channel. The *Flow Window* is expressed as the highest *Flow Sequence* that can be sent by the Airborne IPS System, i.e., the Airborne Radio can compute the *Flow Window* as the most recently received *Flow Sequence* incremented by the number of bytes that can be accepted currently.
  - The Airborne Radio should issue a new *Flow Window* whenever appropriate (e.g., when the previous *Flow Window* was partially consumed and radio resources are available again)
  - Flow Sequence* and the *Flow Window* counters use a serial number arithmetic as defined in RFC 1982. This solves “wrap-around” issues.
  - Note that expressing the flow window in terms of *Flow Sequence* prevents some race conditions.

**Commented [FW19]:** Is this happening only once, or Airborne IPS System can do that announcement at any time?

Also, the diagram suggests that no packets can be sent to the radio until the Flow Window is received? If this is the intention, then this should be stated explicitly.

**Commented [JZ20R19]:** The initial value is sent until the Airborne IPS System receives a *Flow Window* from the Airborne Radio

**Commented [FW21R19]:** The question stands: Can IPS Airborne system send data packet to radio before Flow Window message is received? If this is forbidden by this protocol, then the link initialization on the layer 3 will be delayed until the CIRI flow window is received.

**Commented [JZ22R19]:** The Airborne IPS System needs to wait for the first control-plane CIRI message, that will either establish the flow window (if the corresponding Flow Window option is present), or it will disable flow control for the datalink channel (if the corresponding Flow Window option is absent).

**Commented [FW23]:** This becomes clearer later in the text, but at this stage it should be explained that Airborne Radio adds the number of bytes it can accept into the given flow to the most recently received flow sequence and this gives the value of flow window.

With the current text it is not clear what is actually represented by the Flow Window and why Flow Sequence is needed for this.

Also, what is the advantage of this system over a system where radio reports the number of bytes it can accept in the given flow/queue?

**Commented [JZ24R23]:** Text updated. Is it better now?

## 2.0 CIRI PROTOCOL DESCRIPTION

- If the Airborne Radio does not implement flow control for the channel, then control-plane CIRI messages sent by the radio do not contain *Flow Window*. This indicates that flow control should be disabled for the channel.
- For each data-plane CIRI message containing an air-to-ground packet within the flow-controlled datalink channel, the Airborne IPS System increments the *Flow Sequence* by the size of the packet (in bytes), effectively consuming part of the issued *Flow Window*. If the *Flow Sequence* cannot be incremented without exceeding the *Flow Window* (or if there is no *Flow Window* issued yet), then the air-to-ground packet is kept in a queue until the *Flow Window* is extended, until the packet expires, or until the packet is processed in another way (e.g., discarded when it became too ~~sent via a different datalink~~).

The goal of the flow control mechanism is to keep the Airborne Radio internal queues low especially in the (expected) situation where the link between Airborne IPS System and the Airborne Radio has much higher throughput than the air-ground link. This enables prioritization (non-absolute) within the Airborne IPS System and helps to reduce the amount of lost data during a failover. Generally, the amount of data waiting in the Airborne Radio must be above a radio-specific threshold to achieve the optimal performance. For example, a SATCOM radio requests resources (e.g., timeslots) from the access network based on amount of queued data. If the flow control would keep SATCOM queues too low, the SATCOM radio would request less than the maximum number of timeslots from the access network despite additional SATCOM data queued in the Airborne IPS System; this would degrade the overall system performance.

## 2.6 Airborne Radio Reference Model

This section presents a notional, non-normative Airborne Radio architecture, together with a possible mapping of the architecture elements to CIRI functions.

As shown in Figure 2-7, the Airborne Radio implements several transmit queues (e.g., to enable prioritization and different handling for data with different QoS). These transmit queues are described in CIRI as datalink channels. If the underlying L2/L1 layers do not distinguish between data from different transmit queues, then the Airborne Radio can report the same channel *Status* for all provided datalink channels. Alternatively, if each transmit queue is associated with a negotiated air-ground session (e.g., PDP contexts used in Satcom), then the reported *Status* for each datalink channel should reflect the status of the corresponding session.

**Commented [FW25]:** Recommendation: remove the whole part that starts with "or until the packet is processed in another way...". The current text may raise a few questions, such as "what with link local packages?" or "are all ground destinations are reachable via all datalinks?".

**Commented [JZ26R25]:** We should mention that the packet might be processed in other ways, but he send-via-other-datalink example is removed from this place to deemphasize this option. See also my response to similar comment in section 4.5.1

**Commented [FW27]:** Suggestion: "The goal of the above mechanism is to keep the Airborne Radio internal queues low. This enables prioritization..."

Question: how does this mechanism guarantees that the radio queues are kept low?

**Commented [JZ28R27]:** If the internal queues in the radio are receiving only CIRI-flow-controlled packets from the Airborne IPS System, then it is guaranteed that the queues will never exceed level implied by the flow window issued by the radio.

**Commented [FW29R27]:** Agree, but I would argue that the term "internal queues low" is reaching a bit too far because of fluid definition of "low" and whether "low" is actually desired in the radio.

Maybe the better wording is: "The goal of the flow control mechanism is to prevent the Airborne Radio internal queues from overflowing".

2.0 CIRI PROTOCOL DESCRIPTION

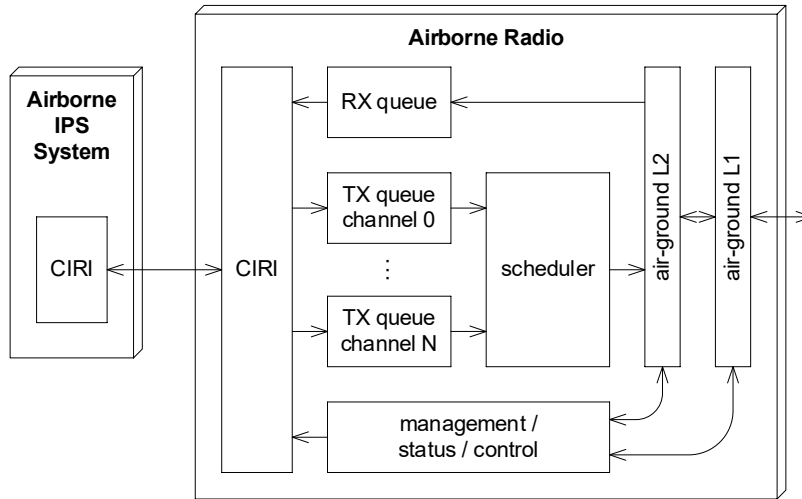

Figure 2-7 – Notional Airborne Radio Architecture

If the data plane CIRI is used, then the air-to-ground packets received from the Airborne IPS System are marked with a *Channel ID*, which identifies a transmit queue that is used for the given packet.

If the CIRI flow control mechanism is used, then the space available in a transmit queue might be directly reflected in the flow window issued for the corresponding datalink channel. When the queue becomes full, then the corresponding flow window is (implicitly) exhausted and the Airborne IPS System will not send additional packets to that channel. When some packets from the queue are processed, either by being delivered to ground or discarded, then the Airborne Radio extends the flow window to account for the newly available queue space.

3.0 CIRI PROTOCOL MESSAGE STRUCTURE

3.0 CIRI PROTOCOL MESSAGE STRUCTURE

3.1 Message Format

CIRI message consists of a CIRI header and a sequence of CIRI options. All integers are encoded in network byte order (i.e., big endian).

A CIRI message is a “data-plane CIRI message” when the *Data Plane* flag set to 1; otherwise, it is a “control-plane CIRI message.”

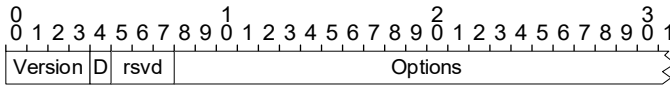

Figure 3-1 – CIRI Message Format

Table 3-1 – CIRI Message Fields

Field	Description	Value
<i>Version</i>	4-bit identifier	0x0: Invalid 0x1: Current version 0x2 to 0xF: Reserved for future use
<i>Data Plane (“D”)</i>	1-bit flag, identifying whether the message is a control-plane message or a data-plane message	0: Control-plane CIRI message. Packet Data option must not be present. 1: Data-plane CIRI message. There must be exactly one Packet Data option present (see Section 2.4.2).
<i>rsvd</i>	3-bit unused field. Initialized to zero by the sender and must be ignored by the receiver	b000
<i>Options</i>	Variable-length field spanning to the end of this CIRI message. It consists of a sequence of one or more CIRI options. Order of options is not significant.	

**Commented [FW30]:** Recommendation: Maybe the section about syntax of the messages could be moved beyond the current section 5? Here we could have an abstract description of the options and their attributes. This way the document could be structured as follows:  
4. CIRI Options  
5. CIRI Protocol Operation  
6. CIRI Message Syntax

**Commented [JZ31R30]:** This rearrangement may avoid some of the current chicken-and-egg problems, but not generally (because references to terms defined in “Protocol Operation” are mostly needed to describe the option semantics, not syntax) Also, the change would split information about individual options to even more places, which I’m afraid would make it more difficult to find relevant information.

**Commented [FW32]:** Suggestion: rephrase to say that D=0 means Control Plane or Flow Control. At the beginning of the document, we distinguish these three categories of messages. See my comment that I added in section 2.1 for alternative approach.

**Commented [JZ33R32]:** There are actually two types of CIRI messages (control-plane and data-plane), ale flow control is a mechanism that uses both of them. Text in 2.1 updated slightly to emphasize this. Is it clearer now?

3.2 Option Format

The following figure illustrates the CIRI option format.

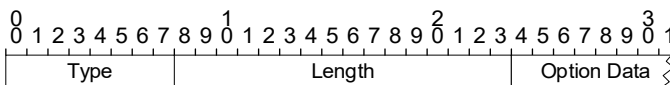

Figure 3-2 – CIRI Option Format

Table 3-2 – CIRI Option Fields

Field	Description	Value
<i>Type</i>	8-bit unsigned integer Identifies a specific CIRI option	Refer to Table 3-3
<i>Length</i>	16-bit unsigned integer Denotes the length in octets of the <i>Option Data</i> field (not including <i>Type</i> and <i>Length</i> ).	0 to 2 <sup>16</sup> -1
<i>Option Data</i>	Variable length field dependent on the specific option	

**Commented [FW34]:** What is the unit of Length: bytes or bits? I am guessing bytes.

Length = len(Option data)?  
OR  
Length = 3 (or 24) + len (Option data)?

Based on the specification below it’s the first case. I think it should be said here explicitly.

**Commented [JZ35R34]:** fixed

3.0 CIRI PROTOCOL MESSAGE STRUCTURE

If an option is received with an unrecognized *Type*, with undefined semantics in a given context (e.g., Expiration Time option in a control-plane CIRI message), or with a *Length* value that is less than expected, then the option must be ignored silently, and the remainder of the CIRI message must be processed as if the option was not present.

If an option is received with a *Length* greater than expected, then the recognized beginning of the option must be processed up to the expected length, and the surplus bytes must be ignored.

Table 3-3 summarizes the options defined for the CIRI protocol. The table also indicates in which situations the presence of the protocol option is mandatory (M), optional (O), or conditional (C) based specific use cases; notes are indicated by square brackets. Options that can be included multiple times in a CIRI message are marked as “multiple.”

Table 3-3 – Common IPS Radio Interface Option Applicability

Option Type	Option Name	Section in this document	Control Plane		Data Plane [1]	
			Airborne Radio to IPS System	IPS System to Airborne Radio	Airborne Radio to IPS System	IPS System to Airborne Radio
0	Reserved					
1	Datalink Identifier	3.3.1	M	M	M	M
2	Reserved					
3	Link Instance	3.3.2	O			
4	Datalink Context	3.3.3	O			
5	Channel Status	3.3.4	M, multiple			
6	Flow Window	3.3.6	C, multiple [2]			
7 – 127	Reserved for future extensions					
128	Packet Data	3.3.7			M	M
129	Channel Identifier	3.3.8		O		O
130	Expiration Time	3.3.9				O
131 – 133	Reserved for future extensions					
134	Flow Sequence	3.3.5		C, multiple [2]		C [2]
135 – 252	Reserved for future extensions					
253	Reserved for experimental use					
254	Reserved					
255	Reserved					

Notes:

- Applicable only when the CIRI protocol is used to exchange data-plane messages between the Airborne IPS System and an Airborne Radio.
- When the flow control functionality is used, the option is mandatory per the use cases described in the identified section in this document.

Commented [FW36]: Suggestion: If the Length is shorter than expected the option is ignored.

Commented [JZ37R36]: Case added to the paragraph above

Commented [SM38]: M23 (Mike): consider making these "conditional"

3.3 Message Option Specification

3.3.1 Datalink Identifier Option

This option identifies a datalink (and the associated Airborne Radio CIRI endpoint) in the scope of the aircraft. It must be present once in every CIRI message. Any



3.0 CIRI PROTOCOL MESSAGE STRUCTURE

CIRI message without Datalink Identifier option, or with an unexpected *ID* value should be ignored.

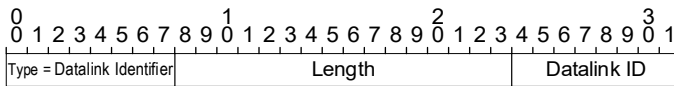

Figure 3-3 – Datalink Identifier Option

Table 3-4 – Datalink Identifier Option Fields

Field	Description	Value
Type	Datalink Identifier	1
Length	Option length	1
Datalink ID	8-bit unsigned integer Represents a configured datalink ID	0 to 255

COMMENTARY

The *Datalink ID* value uniquely identifies an Airborne Radio CIRI endpoint within an individual aircraft. The value is meaningful only within the context of an individual aircraft, e.g., different aircraft may use different values to identify the same datalink.

3.3.2 Link Instance Option

This option allows the Airborne Radio to announce the current *Link Instance ID*, which identifies the combination of the datalink technology and a particular access network (and thus also an access network service provider). The values of *Link instance ID* are defined in ICAO Doc. 9896 Part1, Section 2.5.11. The Airborne IPS System may use this value directly in the AGMI protocol when it is required for global mobility (reference ICAO Doc. 9896).

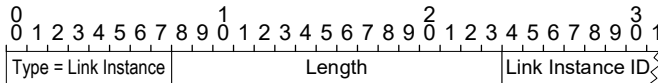

Figure 3-4 – Link Instance Option

Table 3-5 – Link Instance Option Fields

Field	Description	Value
Type	Link Instance	3
Length	Option length	1 to 8
Link Instance ID	Variable length unsigned integer. Represents a combination of the datalink technology and a particular access network, which therefore includes identification of a Communication Service Provider (CSP).	0 to $2^{8-\text{Length}}-1$

COMMENTARY

The Airborne IPS System may use the *Link Instance ID* as an input to the Multilink Decision Engine (MDE) function (reference ARINC 858

**Commented [SM39]: M23 - Luc:** example would be beneficial:  
 -How the link instance ID is used (multilink, AGMI; ref to MDE in Part 1)  
 -How the link instance ID is composed/what it looks like

**Commented [FW40]:** This is the first time where "Link instance ID" and "its global repository" are mentioned. It would be adding a section in the introductory section explaining why Link Instance IDs are important for CIRI and why IPS Radio needs to know about those?

I also assume that there is 1:1 relation with Link ID and Link Instance ID – is that correct assumption?

**Commented [JZ41R40]:** Text updated

Link Instance ID has a global scope (so the same value means the same thing in every aircraft), while the Datalink ID is something local to the aircraft

Also, a radio (e.g. Ldacs) will use a constant Datalink ID, but it may report different Link Instance IDs over time, based on the current CSP (e.g. different for SITA and ARINC)

This functionality is not needed by the CIRI, but it is envisioned as necessary for AGMI operation

3.0 CIRI PROTOCOL MESSAGE STRUCTURE

Part 1, Section 3.3.6.2). Note that the *Link Instance ID* applies to all channels provided by the datalink.

3.3.3 Datalink Context Option

The Datalink Context option may be used by the Airborne Radio to indicate that a mobility and multilink message needs to be sent over the datalink. When the Airborne IPS System receives a Datalink Context option with a *Context* value that is different than the previously received *Context*, then the Airborne IPS System should send a mobility and multilink signaling message over this datalink (see Section 4.3.2). The Airborne IPS System should not interpret the *Context* in any other way.

COMMENTARY

The “mobility and multilink signaling message” is assumed to be an AGMI request, as specified in ICAO Doc. 9896. For example, if the ground infrastructure of a VHF datalink needs to receive a mobility and multilink signaling message (e.g., an AGMI request) from the aircraft after any handover to another ground station (e.g., to keep its routing configuration up to date), then the Airborne Radio might use some “Ground Station ID” as value of the *Context*.

This mechanism is provided only for datalinks that need to be able to solicit a mobility and multilink signaling message in some circumstances. If the datalink does not have such need, then the Datalink Context option will not be used.

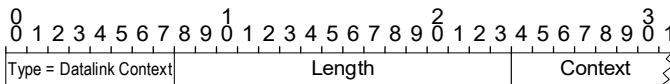

Figure 3-5 – Datalink Context Option

Table 3-6 – Datalink Context Option Fields

Field	Description	Value
Type	Datalink Context	4
Length	Option length	1 to 8
Context	Variable length byte string	

3.3.4 Channel Status Option

This option specifies current status of one datalink channel (see Section 4.2) managed by the Airborne Radio endpoint.

Every Airborne Radio endpoint must report status for *Channel ID* = 0 (“primary channel”) channel and may report statuses for other channels. A CIRI message must not contain multiple Channel Status options with the same *Channel ID*.

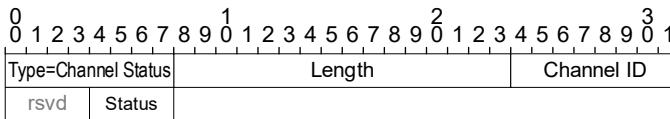

Figure 3-6 – Channel Status Option

**Commented [FW42]:** Why is this option needed? What is the use case here? Why does the radio cares about this and in which circumstances this message is sent to the IPS Airborne System? Does this target a handoff (e.g., VDLm2 handoff) and reconnection to a different access router? The text written so far does not explain much.

Suggestion: maybe before or after “Table 4 3 – Common IPS Radio Interface Option Applicability” we could have bullets listing all options along with their short description (purpose).

**Commented [JZ43R42]:** Description updated. Is it better now?

**Commented [FW44R42]:** It is better now, however the current text does not explain what the value of the context should be. From IPS System point of view we do not care. All we care if the value is the same or different. However, the radio manufacturers will be asking what to put in the option? Maybe an example could clarify this option more?

**Commented [JZ45R42]:** TODO: example [?]

**Commented [FW46]:** This is also the first occurrence of the “datalink service”

**Commented [JZ47R46]:** Forward reference added

**Commented [FW48]:** Recommendation: add a section with a reference model of a radio that supports CIRI. That section could include the definition and rationale of the terms and concepts used here such as “Service” or “Primary Service”, “Flows” and how they may be related to multiple transmission queues in the radio.

**Commented [JZ49R48]:** After updates to the relevant sections (mainly 3.1.3, 5.2), is this still necessary?

**Commented [OML50R48]:** Fryderyk – Not strictly necessary, but I consider this to be very useful and make the specification easier to read (much easier IMHO). This would help radio as well as IPS system vendors with orientation in the protocol.

**Commented [FW51]:** Recommendation: add a section with a reference model of a radio that supports CIRI. That section could include the definition and rationale of the terms and concepts used here such as “Service” or “Primary Service”, “Flows” and how they may be related to multiple transmission queues in the radio.

**Commented [JZ52R51]:** After updates to the relevant sections (mainly 3.1.3, 5.2), is this still necessary?

**Commented [JZ53R51]:** See section 2.6

**Commented [FW54]:** “should not” or “must not”? If “should not” then what is the processing if it occurs (we actually do get message with two statuses for the same Service ID)?

**Commented [JZ55R54]:** corrected

## 3.0 CIRI PROTOCOL MESSAGE STRUCTURE

Table 3-7 – Channel Status Option Fields

Field	Description	Value
Type	Channel Status	5
Length	Option length	2
Channel ID	8-bit unsigned integer Identifies a datalink channel as defined in Section 4.2	0 to 254: Datalink channel identifier 255: Reserved for future use
rsvd	4-bit unused field This field must be initialized to zero by the sender and must be ignored by the receiver	0x0
Status	4-bit unsigned integer Indicates the status of the datalink channel	<ul style="list-style-type: none"> <li>0: Datalink channel is not operational ("link_down")</li> <li>1 to 6: Datalink channel is operational. Meaning of individual operational values is datalink-specific, e.g., to indicate some sub-nominal performance [1].</li> <li>7: Datalink channel is operational with nominal performance ("link_up")</li> <li>8 to 15: Reserved for future extensions. Unless configured otherwise, the receiver should treat these values as "unknown".</li> </ul>
Notes: 1. The following values are recommended for sub-nominal channel status: <ul style="list-style-type: none"> <li>1: Degraded datalink channel with an unknown performance and unknown impact on the user traffic ("best_effort")</li> <li>4: Degraded datalink channel with a known performance degradation and known impact on user traffic ("link_degraded")</li> </ul>		

## COMMENTARY

The status values 0 to 7 are chosen to correspond to the 3-bit *Status* field from the Datalink option in the AGMI protocol, as specified in ICAO Doc. 9896.

## 3.3.5 Flow Sequence Option

This option is used for the purpose of flow control (see Section 4.5). It signals the current *Flow Sequence* number for the given flow-controlled datalink channel, which is a counter of bytes of air-to-ground packets sent within the datalink channel, used by the Airborne IPS System endpoint. It might be included in both control-plane and data-plane CIRI messages.

When the Flow Sequence option is included in a data-plane CIRI message, it indicates value of the *Flow Sequence* counter after including the size of the data-plane packet in this CIRI message. Note that the Flow Sequence option is included in all data-plane CIRI messages that are sent by the Airborne IPS System and which carry a data-plane packet that belongs to a flow-controlled datalink channel.

Note that the *Flow Sequence* counter uses a serial number arithmetic (modulo  $2^{32}$ ) as defined in RFC 1982.

**Commented [FW56]:** At this stage the reader does not know what the "flow" means.

**Commented [JZ57R56]:** The section 3.1.3 now contains a definition of flow.

**Commented [FW58]:** In what cases we would want to include Flow Sequence option with a data packet?

**Commented [JZ59R58]:** Whenever a that packet belongs to a configured flow. This is specified in section 5.5.1. Note added also here.

**Commented [FW60R58]:** I understand then that the "Flow Window" option is mandatory every time we send a packet to a flow-controlled service. Maybe this could be phrased better. Now the text says that the option "might be included in (...) data plane CIRI messages" and the just final note says it's mandatory in certain messages.

And let me rephrase my original question: what is the purpose of adding the "Flow Sequence" option to the message carrying data packet? What do we expect to radio to do with it? I assume that the initial exchange of "Flow Sequence" and "Flow Window" took place, so both: IPS system and IPS radio keep the current value of the flow sequence number.

3.0 CIRI PROTOCOL MESSAGE STRUCTURE

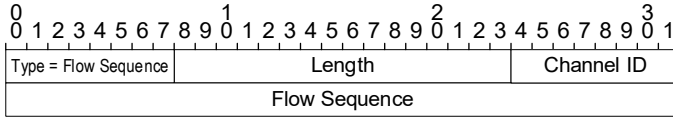

Figure 3-7 – Flow Sequence Option

Table 3-8 – Flow Sequence Option Fields

Field	Description	Value
Type	Flow Sequence	134
Length	Option length	5
Channel ID	8-bit unsigned integer Identifies a flow-controlled datalink channel	0 to 254: Datalink channel identifier 255: Reserved for future use.
Flow Sequence	32-bit unsigned integer Indicates the current Flow Sequence used by the Airborne IPS System endpoint	0 to 2 <sup>32</sup> -1

3.3.6 Flow Window Option

This option is used for the purpose of flow control (see Section 4.5). In each control-plane CIRI message sent by the Airborne Radio endpoint, there is one Flow Window option for each flow-controlled datalink channel. The Flow Window option may contain the Flow Window field.

A Flow Window option without the Flow Window field signals a request for Flow Sequence and invalidates any flow window issued previously for the datalink channel (see Section 4.5.1).

When a Flow Window option contains the Flow Window field is present in a Flow Window option, then the value of the field indicates the highest Flow Sequence number that can be transmitted by the Airborne IPS System in the given datalink channel.

The Flow Window uses serial number arithmetic (modulo 2<sup>32</sup>), as defined in RFC 1982. The Airborne Radio should use smallest possible Flow Window, that does not impair datalink performance.

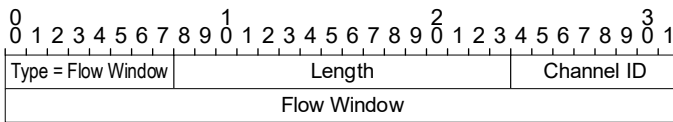

Figure 3-8 – Flow Window Option

Table 3-9 – Flow Window Option Fields

Field	Description	Value
Type	Flow Window	6
Length	Option length	1 (if the Flow Window field is not included) or 5 (if the Flow Window field is included)
Channel ID	8-bit unsigned integer Identifies a flow-controlled datalink channel	0 to 254: Datalink channel identifier 255: Reserved for future use.

Commented [FW61]: Again, at this stage the reader does not know what the "configured flow" means.

Commented [JZ62R61]: The section 3.1.3 now contains a definition of flow.

Commented [OML63R61]: Fryderyk - Suggest adding a lead-in paragraph:  
"The Flow Window option may contain the Flow Window field"  
That could be followed by the text that describes the optimistic case where the field is included.

ZJ - Accepted

Commented [FW64]: What does this mean?

Commented [JZ65R64]: Wording updated. The behavior is described in more detail later, a link added.

Commented [OML66R64]: Fryderyk - "If the Flow Window field is present in the Flow window option, then the value of the field indicates the highest Flow Sequence number that can be transmitted by the Airborne IPS System in the given datalink service."

ZJ - Accepted

Commented [FW67]: Explain, that if the Length=1 then the "Flow window" field is not included.

3.0 CIRI PROTOCOL MESSAGE STRUCTURE

Field	Description	Value
Flow Window	Optional 32-bit unsigned integer Indicates the highest flow sequence number that can be accepted by the Airborne Radio endpoint.	0 to 2 <sup>32</sup> -1

3.3.7 Packet Data Option

This option must be present in any data-plane CIRI message. This option must be the last option encoded in the data-plane CIRI message.

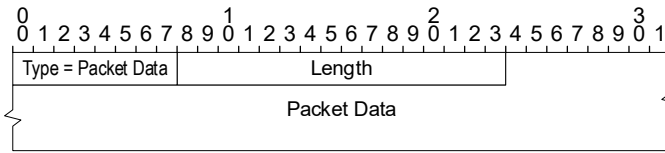

Figure 3-9 – Packet Data Option

Table 3-10 – Packet Data Option Fields

Field	Description	Value
Type	Packet Data	128
Length	Option length	0: No packet data 1 to 2 <sup>16</sup> -1: length of packet data
Packet Data	Variable-length octet string packet containing the data-plane packet bytes	

3.3.8 Channel Identifier Option

This option may be present in any data-plane CIRI message. It indicates that the accompanied packet belongs to the identified datalink channel (see Section 4.2).

For air-to-ground packets, the Airborne Radio is requested to use the identified datalink channel to deliver the packet. The chosen channel may be reflected by flow control (see Section 4.5) and treatment within the radio (e.g., prioritization).

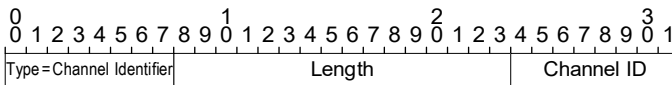

Figure 3-10 – Channel Identifier Option

Table 3-11 – Channel Identifier Option Fields

Field	Description	Value
Type	Channel Identifier	129
Length	Option length	1
Channel ID	8-bit unsigned integer Identifies a channel as defined in Section 4.2.	0 to 254: Datalink channel identifier 255: Reserved for future use.

**Commented [FW68]:** Flow Control uses a concept of “Flows” and the document suggests that the radio may support many of them. How do we send the data packet to a particular flow? Is it happening by sending together Flow Sequence option along with the Data Packet option?

**Commented [JZ69R68]:** Yes (as described in section 5.3.4.1)

**Commented [JZ70]:** This can potentially significantly simplify handling of received data-plane CIRI messages.

3.0 CIRI PROTOCOL MESSAGE STRUCTURE

3.3.9 Expiration Time Option

This option may be present in a data-plane CIRI message from Airborne IPS System to the Airborne Radio. It indicates that after the expiration time, the conveyed packed is expired and may be discarded by the radio.

If the radio is capable of tracking expiration time for individual packets, it should discard any packet not delivered within the expiration time, to preserve bandwidth for other traffic.

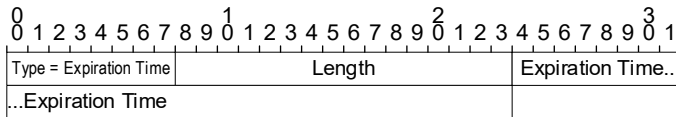

#### 4.0 CIRI PROTOCOL OPERATION

#### 4.0 CIRI PROTOCOL OPERATION

CIRI operates between a pair of endpoints. Each pair consists of one Airborne IPS System endpoint and one Airborne Radio endpoint. Both endpoints must be configured with a *Datalink ID*, uniquely identifying the pair within the aircraft. Every CIRI message exchanged between those endpoints must contain a Datalink Identifier option with this *Datalink ID* value.

#### 4.1 Transport Requirements

CIRI operation relies on a datagram-oriented transport mechanism between the Airborne IPS System endpoint and Airborne Radio endpoint. The transport protocol must support a payload size that is sufficient to accommodate the largest CIRI message in a particular deployment. As a minimum, the transport protocol should support a payload size of 1307 bytes, which accommodates a data-plane CIRI message containing IPv6 packets no larger than 1280 octets plus all currently defined CIRI options. Per the IPS Profiles in RTCA DO-379A and EUROCAE ED-262A, IPv6 packets larger than 1280 bytes do not have to be supported.

#### COMMENTARY

Control-plane CIRI messages are expected to be much smaller than data-plane CIRI messages. A 1307-byte control-plane CIRI message can contain all mandatory and optional information sent from an Airborne Radio to the Airborne IPS System, including Channel Status and Flow Windows for up to 98 flow-controlled datalink channels (which vastly exceeds the expected amount of deployed datalink channels).

Because the communication might be initiated by both peers, it is recommended that addressing should be statically configured on both endpoints and that all control-plane CIRI messages from one endpoint use the same addressing.

Data-plane CIRI messages, if used, may use the same transport channel addressing as the control-plane CIRI messages, or it might use one or more separate transport channels. This is a deployment option.

#### COMMENTARY

For example, if the CIRI protocol uses UDP transport over IPv4 as shown previously in Figure 2-3, then both endpoints should be configured with the same four-tuple of:

(IPS System IPv4 address, IPS System UDP port number,  
Radio IPv4 address, Radio UDP port number).

These ports/addresses are used for all outgoing control-plane CIRI messages. If the CIRI protocol is also used for exchanging data-plane messages, then there may be another four-tuple for data-plane CIRI messages.

Single transport channel might be shared by multiple logical CIRI endpoints. In that case, these are distinguished by *Datalink ID*.

#### 4.2 Channels

A datalink channel is a “transport service” for sending air-to-ground packets; this is different than the radio RF channel. Each air-to-ground packet given to the Airborne

**Commented [SM71]:** M23 (zbig): consider rewording to “means” / “transmission channel”  
... service for exchanging data to be sent over the air-to-ground media

#### 4.0 CIRI PROTOCOL OPERATION

Radio shall be associated with one datalink channel. If the radio gets the packet from a data-plane CIRI message, then the channel is identified by the Channel Identifier option (see Section 4.4.3). Other data plane interfaces and protocols may define other means to specify a channel for the air-to-ground traffic.

A datalink channel is identified by *Channel ID*, which is an integer between 0 and 254:

- *Channel ID* 0 identifies the primary channel; all Airborne Radios must provide this channel.
- *Channel ID* 1 to 254 identify additional channels, if provided by the Airborne Radio. Semantics of these channels are deployment specific.
- *Channel ID* 255 is reserved. A receiver must ignore any option that contains *Channel ID* 255.

The CIRI protocol includes the *Channel ID* in the Channel Status option, Channel Identifier option, Flow Sequence option, and Flow Window option.

For each of the supported channels, the Airborne Radio reports the channel status and accepts air-to-ground packets associated with each channel. The meaning of the individual *Channel IDs* is radio specific. It is assumed that the set of channels provided by an Airborne Radio does not change over time, and that the Airborne IPS System is configured with regard to how individual *Channel IDs* provided by an Airborne Radio are used.

#### COMMENTARY

As an example, an Airborne Radio may provide a “high-priority” channel for RCP/RSP-bound traffic (e.g., ATS applications), and a second “lower priority” channel for traffic without RCP/RSP constraints (e.g., most AOC applications).

It is recommended that mobility and multilink signaling messages (e.g., AGMI messages) are sent over the primary channel (*Channel ID* = 0).

### 4.3 Airborne IPS System Endpoint Operation

#### 4.3.1 Configuration

The following must be configured in the Airborne IPS System for each Airborne Radio CIRI protocol peer:

- Transport Mechanism Parameters – configuration of the on-aircraft communication means for message exchanges between CIRI protocol peers (see Section 4.1). There may be a separate configuration for the control plane and for the data plane if data-plane CIRI messages are used.
- *Datalink ID* – an 8-bit unsigned integer matching the *Datalink ID* of the peer Airborne Radio CIRI endpoint.
- ResponseInterval – a time interval that Airborne IPS System endpoint waits for a response to any control-plane CIRI message sent to an Airborne Radio endpoint.
  - Default value: 3000ms
- HelloInterval – a maximal time between two consecutive control-plane CIRI messages sent by Airborne IPS System endpoint

**Commented [FW72]:** This sentence pretty much repeats what the last sentence in the previous paragraph says.

**Commented [FW73]:** And if this is included in the data plane message then what happens to the packet?

**Commented [JZ74R73]:** Then it is treated as if it belongs to the default channel (because there is no valid Channel identifier option)

**Commented [FW75]:** All control plane messages?

**Commented [FW76]:** Maybe “HelloInterval” will be better here?

I also assume that the control-plane messages are being sent constantly by the Airborne IPS System, even if “MaxUnanswered” is reached and radio is considered “broken”. It would be useful to clarify this somewhere.

**Commented [JZ77R76]:** Renamed  
Note added to section 4.3.2

**Commented [FW78]:** Suggestion: “sent by”



#### 4.0 CIRI PROTOCOL OPERATION

- Default value: 5000ms
- MaxUnanswered – if the number of CIRI protocol messages unanswered by the Airborne Radio exceeds this number, then the radio is considered non-operational, and the datalink channel status for all applicable channels is set to the non-operational status “unknown”.
  - Default value: 2
- Datalink Channels – When the CIRI protocol is used to exchange data-plane messages, then the Airborne IPS System may be configured to send different air-to-ground packets via different channels. Configuration of the function that assigns a *Channel ID* to each air-to-ground packet is an implementation detail of the Airborne IPS System that is not specified in this document.
  - If the Airborne IPS System implements flow control, then each datalink channel may be optionally configured to be flow-controlled.

#### COMMENTARY

For example, an Airborne IPS System implementation can distinguish between "High priority" and "Low priority" air-to-ground traffic. For each of these traffic types, this implementation can be configured with:

- A *Channel ID*, associated with the traffic type.
- A Boolean flag, specifying whether flow control is used for this traffic type.

To determine the current capability of the Airborne Radio to forward air-to-ground packets of a given *Channel ID*, the Airborne IPS System can use the channel *Status* reported by the Airborne Radio. When an air-to-ground packet of a given traffic type is sent to the Airborne Radio, the Airborne IPS System includes the Channel Identifier option with the configured *Channel ID*.

Note that the logic in the Airborne IPS System might be more complex and the decision about what channel is used for what air-to-ground packet may be based on the currently reported Channel Statuses and any other available parameters.

An Airborne IPS System implementation does not have to support all possible valid CIRI protocol configurations, and it might need other configuration information not specified in this document, regarding for example:

- Inclusion of other metadata in data-plane messages (e.g., Expiration Time option)
- Processing of status information received from the Airborne Radio (see Section 4.3.3).
- Handling of packets waiting in the “outbox” queues (for example expiration policy and prioritization configuration).

**Commented [FW79]:** Suggestion: “CIRI endpoint at the radio”

**Commented [JZ80R79]:** But the intent was to use this as a “health monitoring” of the datalink. If there are no CIRI responses, then the datalink should not be used (even if, for example, the data plane does not use CIRI)

**Commented [FW81R79]:** OK, but place your answer somewhere in the text. Also, “broken” -> “non-operational” would be slightly better.

**Commented [JZ82R79]:** Accepted. The primary purpose of datalink status added to section 4.3.2.

4.0 CIRI PROTOCOL OPERATION

4.3.2 Control Plane Operation

Airborne IPS System endpoint sends a control-plane CIRI message containing configured Datalink Identifier option to Airborne Radio endpoint immediately after initialization and then periodically (with HelloInterval period).

If the IPS does not receive a response within ResponseInterval for a control-plane CIRI message, then another control-plane CIRI message is sent. If the IPS does not receive a response for more than MaxUnanswered control-plane CIRI messages in a row, then the datalink is considered to be non-operational and status is set to the non-operational status “unknown” for all channels provided by the datalink.

COMMENTARY

When an Airborne Radio is considered to be non-operational as described above, then the Airborne IPS System sends a control-plane CIRI message to the Airborne Radio every ResponseInterval seconds until it receives a control-plane CIRI message response.

Upon receiving a control-plane CIRI message with a valid Datalink Identifier option, the Airborne IPS System endpoint updates its status information according to Channel Status options included in that message and possibly from other inputs. It may also note information from other included options. This operation is summarized in Figure 4-1. Only datalink channels reporting an operational status can be used to deliver data-plane packets to the ground. Section 4.3.2.1 contains further recommendations for processing of the information from the Airborne Radio.

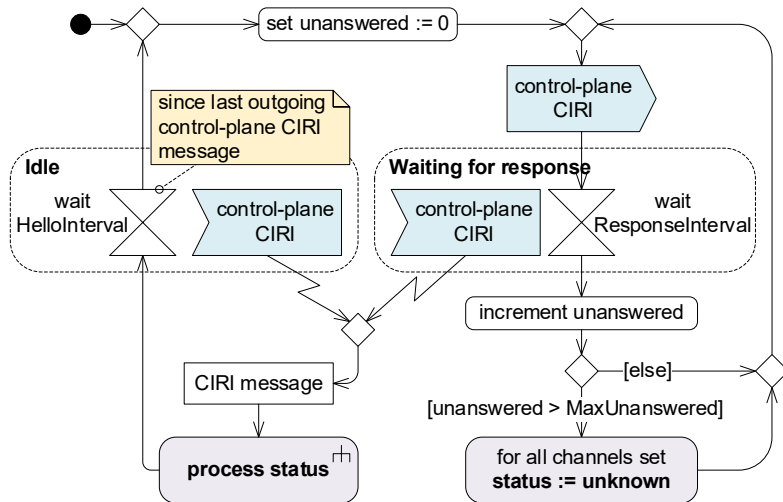

Figure 4-1 – Airborne IPS System Endpoint Control Plane Operation

When an Airborne IPS System receives a control-plane CIRI message with a Datalink Context option and the Context value is not the same as last Context value received previously from the radio (or if the previous control-plane CIRI messages contained no Datalink Context option), then the Airborne IPS System is requested to

**Commented [FW83]:** This comment was added after reading the whole section. What is the typical recommended data-plane exchange: which options are used?

Table 4-3 shows that the only required ones are:

```

    IPS Sys -----<datalink id> -----> radio
    IPS Sys <--<datalink_id><service status>--> radio
    
```

It would be good to show examples too.

**Commented [JZ84R83]:** To be discussed

**Commented [FW85]:** Please clarify: received by who? IPS System or Airborne Radio? I am guessing that the paragraph talks about IPS System.

Also – a clarification is required how the datalink context is created – how does the radio compute this? What is the action on IPS System once this context is received for the first time?

**Commented [JZ86R85]:** Wording disambiguated. When the context is received for the first time, then the AGMI request must be also sent. (If this happens I the first CIRI message announcing that the datalink is operational, then an AGMI message would be sent anyways)

4.0 CIRI PROTOCOL OPERATION

send a mobility and multilink signaling message over this datalink (see Section 3.3.3).

If the Airborne IPS System endpoint is configured to use the Flow control mechanism, then Section 4.5.1 also applies.

COMMENTARY

In order to achieve optimal datalink performance, the Airborne IPS System should use the provided *Flow Window* as much as possible, i.e., keep the air-to-ground packet in its queues, only if the packet cannot “fit” into the currently active *Flow Window*. On the other hand, a violation of the *Flow Window* by the Airborne IPS System may result with a packet loss, e.g., due to exceeding the capacity of the transmission queue in the Airborne Radio.

4.3.2.1 CIRI Control Plane Message

Control-plane CIRI message sent by the Airborne IPS System endpoint has the *Data-plane* flag set to 0 in the CIRI header and contains exactly one Datalink Identifier option. For each flow-controlled datalink channel (see Section 4.5), there is zero or one corresponding Flow Sequence option.

4.3.3 Status Processing

The protocol specification does not require the Airborne IPS System to process the status information received from the Airborne Radio in any particular way, but the following bullets summarize a representative approach:

- Channel Status options indicate the current status of datalink channels.
  - This is the primary indication whether the datalink can be used to convey data-plane traffic to and from the ground.
  - The Airborne IPS System might use any other appropriate knowledge to supplement (or override) *Status* announced by the radio.
  - If the AGMI is used for mobility and multilink signaling, then the *Status* of the primary channel (*Channel ID = 0*) might directly map to datalink status used in the AGMI protocol, as specified in ICAO Doc. 9896.
- Link Instance option may be used to identify datalink’s current communication service provider.
  - This information might be necessary for the mobility and multilink signaling protocol. In case of AGMI, the value of *Link Instance ID* is intended to be directly used in AGMI Datalink option and preferences, as specified in ICAO Doc. 9896.
- Datalink Context option should be monitored to detect a need to send another mobility and multilink signaling message (see Section 3.3.3).

4.3.4 Data Plane Operation

Optionally, the CIRI may be used for data-plane traffic.

When the Airborne IPS System endpoint receives a valid data-plane CIRI message from the peer radio endpoint, then the carried ground-to-air packet is processed either locally or forwarded towards the destination in the aircraft.

**Commented [FW87]:** This makes the dependency between CIRI and AGMI. I would avoid this and keep this as a note. Something along these lines: “A change in Context value received from the radio means <what?> and may use as a trigger for mobility protocol action if such a protocol operates on the datalink”.

**Commented [JZ88R87]:** To be discussed

**Commented [FW89]:** Does this mean that the IPS System can violate the Flow Window?

**Commented [JZ90R89]:** No, it means that the Airborne IPS System should send as much packets as possible without violating/exceeding the Flow Window. It sounds like the wording is confusing, but I cannot figure out what part can be improved.

**Commented [FW91R89]:** How about we add one more sentence here:

“A violation of the Flow Window by Airborne IPS System may result with a packet loss, e.g., due to exceeding the capacity of the transmission queue in the radio.”

Also, the flow control paragraphs may be moved below the Figure 4-1.

**Commented [JZ92R89]:** Accepted

**Commented [FW93]:** Can we merge this section with the one above? It just one paragraph and it could fit as the second paragraph in the previous section.

**Commented [JZ94R93]:** For constancy reasons, I would prefer to keep the section as is (as we also have sections 4.4.2.1, 4.3.4.1, and 4.4.3.1)

**Commented [FW95]:** Again, “flow” vs “service”. I am not sure what is the difference/relation? Flows/services are not mentioned in “5.3.1 Configuration”.

**Commented [JZ96R95]:** See my comment at 5.2. The configuration section was updated.

**Commented [FW97]:** Note: I would avoid making direct references to AGMI. If we keep making them, we may reach a level of inter-dependency that CIRI and AGMI cannot work without each other. Also, why should radio manufacturers care about AGMI, which lives in the network layer? Recommendation: All references to AGMI should be informative (notes).

**Commented [JZ98R97]:** I tried to avoid references to AGMI in any “normative” part of the CIRI specification for the reasons you mention (this is why description of the Datalink Context option uses “mobility and multilink signaling message”), but I tried to explain the relationship it in the informative parts. Do you think that it is now too interlocked?

**Commented [FW99R97]:** How about the we say the following in this bullet:

**Commented [FW100]:** Note: I would avoid making direct references to AGMI. If we keep making them, we may reach a level of inter-dependency that CIRI and AGMI cannot work without ea

**Commented [JZ101R100]:** I tried to avoid references to AGMI in any “normative” part of the CIRI specification for the reasons you mention (this is why description of the Datalink

**Commented [JZ102R100]:** The whole section 4.3.3 is intended to be non-normative

4.0 CIRI PROTOCOL OPERATION

When the Airborne IPS System wishes to send an air-to-ground packet via this datalink, a data-plane CIRI message with this packet is sent to the peer radio. This CIRI message may contain metadata describing the packet.

If the Airborne IPS System endpoint is configured to use the flow control mechanism, then Section 4.5.1 also applies.

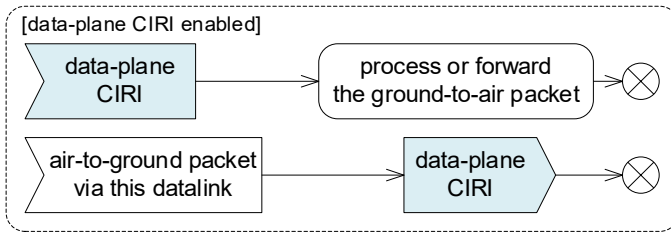

Figure 4-2 – Airborne IPS System Endpoint Data Plane Operation

4.3.4.1 CIRI Data Plane Message

Data-plane CIRI message sent from Airborne IPS System has the *Data-plane* flag set to 1 in the CIRI header and contains exactly one Packet Data option and exactly one Datalink Identifier option. It may also contain:

- zero or one Channel Identifier option
- zero or one Expiration Time option
- zero or one Flow Sequence option.

If the Flow Sequence option is present, then the CIRI message must also contain a Channel Identifier option with the same *Channel ID*.

These options describe properties of the packet carried by the Packet Data option, which must be the last option encoded in the CIRI message.

4.4 Airborne Radio Endpoint Operation

4.4.1 Configuration

The following must be configured in each Airborne Radio CIRI endpoint consistent with the configuration of the Airborne IPS System CIRI protocol peer:

- Transport Mechanism Parameters – configuration of the on-aircraft communication means for message exchanges between CIRI protocol peers (see Section 4.1). There may be a separate configuration for the control plane and for the data plane if data-plane CIRI messages are used.
- Datalink ID – an 8-bit unsigned integer matching the *Datalink ID* of the peer Airborne IPS System CIRI endpoint.
- Datalink Channels – When the CIRI protocol is used to exchange data-plane messages, then the Airborne Radio is configured with one or more datalink channels. It must support at least the primary channel (*Channel ID* = 0), and it may be able to support a number of other channels (see Section 4.2). Each supported channel includes:
  - *Channel ID*, that is used to identify the channel in CIRI messages containing the Channel Status option or Channel Identifier option.

**Commented [FW103]:** I think I asked this question in one of my previous comments: why is it important to carry the Flow Sequence option with the data packet? Radio is required to track the flow sequence anyway.

**Commented [JZ104R103]:** This is intended to increase robustness of the protocol:

- When CIRI packets are lost or reordered in the transit (admittedly very unlikely)
- When the Airborne Radio restarts

**4.0 CIRI PROTOCOL OPERATION**

- Internal representation of the channel that specifies the status that is reported in the Channel Status option and that determines how air-to-ground packets belonging to this channel are handled when the CIRI protocol is used to exchange data-plane messages.
- Optionally, the channel may be flow-controlled (see Section 4.5), in which case, the Airborne Radio is configured with an internal representation of the channel flow. The internal representation is responsible for managing the *Flow Window* (see Section 4.5.2).

The structure of configuration of the internal representations of datalink channels and flows is an implementation detail of the Airborne Radio that is not specified in this document.

**COMMENTARY**

Implementation do not have to support all possible valid configurations. For example, an Airborne Radio implementation might support only:

- The primary channel (*Channel ID = 0*) with no flow control
- Up to N flow-controlled datalink channels.

**4.4.2 Control Plane Operation**

The Airborne Radio endpoint reacts to events, as summarized in Figure 4-3. Whenever:

- A valid control-plane CIRI message is received from the peer Airborne IPS System endpoint, or
- Datalink channel status changes, or
- Optionally, whenever any other new information is available, e.g., Flow Window or Datalink Context update.

then the radio endpoint sends a control-plane CIRI message (see Section 4.4.2.1).

If the Airborne Radio endpoint is configured to use the flow control mechanism, then Section 4.5.2 also applies.

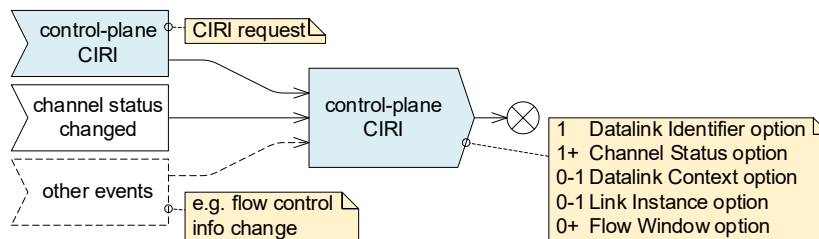

**Figure 4-3 – Airborne Radio CIRI Endpoint Control Plane Operation**

**COMMENTARY**

It is assumed that the datalink channel status tracking function implements hysteresis as necessary to prevent reporting changes of datalink status too frequently. On the other hand, this should be balanced with the need to provide information about datalink status in

4.0 CIRI PROTOCOL OPERATION

a timely manner. Details are deemed datalink and implementation specific.

4.4.2.1 CIRI Control Plane Message

The control-plane CIRI message sent by the Airborne Radio contains:

- one Datalink Identifier option
- one or more Channel Status options with the current status of all configured channels.
- zero or one Link Instance option
- zero or one Datalink Context option
- zero or more Flow Window options (see Section 4.5.2)
  - For each flow-controlled datalink channel, there is one Flow Window option.

4.4.3 Data Plane Operation

Optionally, the CIRI may be used for data-plane traffic.

When the radio endpoint receives a valid data-plane CIRI message from the peer Airborne IPS System endpoint, then the carried air-to-ground packet is queued for transmission to ground over the datalink channel specified in the Channel Identifier option. If the CIRI message does not contain the Channel Identifier option, then *Channel ID* = 0 (the primary channel) is implied. If the CIRI message indicates an invalid *Channel ID* in a Channel Identifier option, then the Airborne Radio should discard the packet.

If the CIRI message contains any other metadata (e.g., Expiration Time option), then this information should be associated with the packet.

Whenever a ground-to-air packet is received from ground, a data-plane CIRI messages with this packet is sent to the peer Airborne IPS System (see Section 2.4.2).

If the Airborne Radio endpoint is configured to use the flow control mechanism, then Section 4.5.2 also applies.

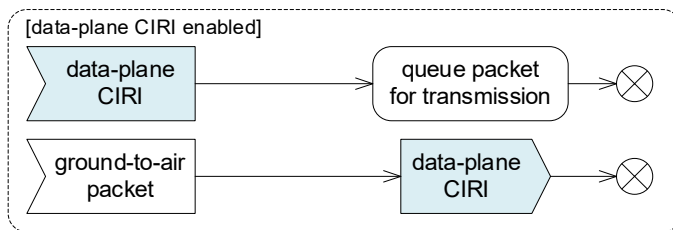

Figure 4-4 – Airborne Radio CIRI Endpoint Data Plane Operation

4.4.3.1 CIRI Data Plane Message

The data-plane CIRI message sent by the Airborne Radio endpoint has the *Data-plane* flag set to 1 in the CIRI header and contains exactly one Datalink Identifier option and exactly one Packet Data option. It may also contain one Channel

## 4.0 CIRI PROTOCOL OPERATION

Identifier option. The Packet Data option must be the last option encoded in the CIRI message.

## 4.5 Flow Control

The flow control mechanism is an optional feature of the CIRI protocol. When data-plane CIRI messages are employed, then the CIRI flow control mechanism provides a means for the Airborne Radio to govern the amount of data sent by the Airborne IPS System.

## COMMENTARY

An implementor of the Flow Control mechanism needs to ensure that the mechanism as such does not degrade the performance allocated to the aircraft. This can be achieved, for example, by applying the Flow Control mechanism only to non-safety-critical data to mitigate potential impact on safety critical data.

A **flow** is a datalink channel that is flow-controlled. The Airborne Radio may be configured to provide a flow control mechanism for zero or more datalink channels, where each datalink channel is flow-controlled independently.

A **flow sequence** is a counter of the bytes of air-to-ground packets. It is assigned by the Airborne IPS System, and for each air-to-ground packet in the flow-controlled datalink channel, the counter is incremented by size of the packet. It is advertised in a Flow Sequence option.

A **flow window** is a license for some amount of air-to-ground data, that the Airborne IPS System can safely pass to the Airborne Radio. The Flow Window is issued by the Airborne Radio and it is expressed as the highest flow sequence number that can be transmitted by the Airborne IPS System in the given datalink channel based on previously received Flow Sequence option.

All mathematical operations (including comparison) on Flow Window and Flow Sequence follow sequence number arithmetic (modulo  $2^{32}$ ), as defined in RFC 1982. This is emphasized in the following text as “sn” subscript ( $+_{sn}$ ,  $\leq_{sn}$ ).

For the overview, see Section 2.5. The operation is described in detail in the following sections.

## COMMENTARY

The main purpose of the flow control mechanism is to limit cumulation of packets in the Airborne Radio, and to instead queue these packets in the Airborne IPS System, without sacrificing the datalink performance. The Airborne Radio should issue the smallest possible Flow Window, that does not impair datalink performance.

## COMMENTARY

The presented flow control mechanism assumes use of the CIRI data-plane functionality. It might be possible to define a similar flow control mechanism working with other data-plane protocols, but this option is not specified in this document.

## 4.5.1 Airborne IPS System Flow Control Operation

For all flow-controlled datalink channels (see Section 4.3.1), the Airborne IPS System keeps track of the current *Flow Sequence* and *Current Flow Window*. The

**Commented [SM105]:** [P3-M22-03 – M.Skorepa/Z.Jaron – HON]: (Luc-Airbus) We may need an analysis/demonstration that the flow control mechanism as such does not degrade the performance allocated to the aircraft.

**Commented [FW106]:** The definition of the “flow” comes very late in the document. Earlier “flow-controlled service” is used. Maybe we should stick to the “flow-controlled service” and forget about the “flow”?

**Commented [JZ107R106]:** The term “flow” is introduced in section 2.5. But agree, “flow-controlled channel” is used interchangeably, and the bare “flow” is not strictly necessary anymore.

**Commented [OML108]:** Existing text moved to commentary



## 4.0 CIRI PROTOCOL OPERATION

*Flow Sequence* should be initialized to zero and the *Current Flow Window* is initialized to “invalid”.

Each control-plane CIRI message sent to the Airborne Radio endpoint must contain a Flow Sequence option for each datalink channel that is configured to be flow-controlled and that has an “invalid” *Current Flow Window*.

When the Airborne IPS System receives a control-plane CIRI message without the Flow Window option for any datalink channel that is configured to be flow-controlled, then flow control should be disabled for this datalink channel until a Flow Window option is received for the channel. When the flow control is disabled for a channel, then data-plane packets belonging to the channel are sent to the Airborne radio unthrottled, as if flow control was not configured for the channel.

When the Airborne IPS System receives a Flow Window option for a flow-controlled datalink channel without the *Flow Window* field (i.e., having *Length* = 1), then it must set the *Current Flow Window* for the channel to “invalid” and return a control-plane CIRI message that contains a Flow Sequence option for each flow-controlled datalink channel which has the *Current Flow Window* “invalid”.

## COMMENTARY

A Flow Window option without the *Flow Window* field is used by the Airborne Radio to solicit the Flow Sequence from the Airborne IPS System. For example, this can be used after the Airborne Radio restarts.

When the Airborne IPS System receives a Flow Window option for a flow-controlled datalink channel that includes the *Flow Window* field (i.e., having *Length* ≥ 5), then the *Current Flow Window* for the given channel is updated to the received value. The *Current Flow Window* remains valid until another Flow Window option is received for that channel or until the channel becomes non-operational (e.g., by receiving *Status* = “link\_down” in a Channel Status option).

When the Airborne IPS System wants to send an air-to-ground packet that belongs to a flow-controlled datalink channel, then it must not exceed the issued *Flow Window*:

If there is a valid *Current Flow Window* for that datalink channel, and if

$$Flow\ Sequence +_{sn} (\text{packet size in bytes}) \leq_{sn} Current\ Flow\ Window,$$

then the *Flow Sequence* for this datalink channel is incremented by the packet size (in bytes) and the packet is sent to the Airborne Radio. The corresponding data-plane CIRI message must include a Flow Sequence option with the updated *Flow Sequence* as well as a Channel Identifier option.

If there is no valid *Current Flow Window*, or if the updated *Flow Sequence* would exceed the window, then the packet must not be sent to the Radio. It should be instead kept in an “outbox” queue in the Airborne IPS System processes the packet another way, e.g., discards the packet because it became too old or sends the packet via a different datalink.

It should be instead kept in an “outbox” queue in the Airborne IPS System. The Airborne IPS System may send the packet to the Airborne Radio when the flow window is extended sufficiently or it may process the packet another way, e.g.,

**Commented [FW109]:** “Flows” are not listed in the configuration parameters.

The term “must contain” – Flow Window and Flow Sequence options are optional as per Table 4.3. What is missing is a statement saying that if flow control system is used then those the use of those options is mandatory.

**Commented [JZ110R109]:** Configuration section (5.3.1) updated

A note added to the Table 4-3. Mandatory usage of the Service Identifier option for non-aggregated flows emphasized in the text.

**Commented [FW111]:** I do not fully understand this. Just correct me if I am making some logical mistake here: Airborne IPS system will be seeing control plane messages without Flow Window option on a regular basis. Example: IPS System has nothing to over A/G link, the radio is periodically queried for the datalink status. Does that mean that every status message is required to use Flow Window option, even if nothing changes at the radio? Or maybe Flow Window option is only sent when only in messages indicating the change in the radio queuing system, e.g., link goes down and the flow windows for every service get invalidated?

If this is the second case, then the current text suggests that that the IPS Airborne System invalidates its information about the current flow window if it does not get Flow Window option. Whenever this happens the IPS system can say “hey – I can send as much as I can”, but this would not be really true.

Please correct me if I am misunderstanding something here.

**Commented [JZ112R111]:** The radio must include the Flow Window option for all flow-controlled channels in all control-plane CIRI messages that it sends. (as specified by second paragraph of 4.5.2) The CIRI protocol tries to be as stateless as possible.

**Commented [FW113]:** Suggesting to replace this part with:

“and if they are sent at excessive rate there is a risk that they will be dropped by the radio”.

**Commented [FW114]:** Again: why?



4.0 CIRI PROTOCOL OPERATION

discard the packet when it becomes too old or send the packet via a different datalink.

Example operation of the data plane in the air-to-ground direction is summarized in Figure 4-5.

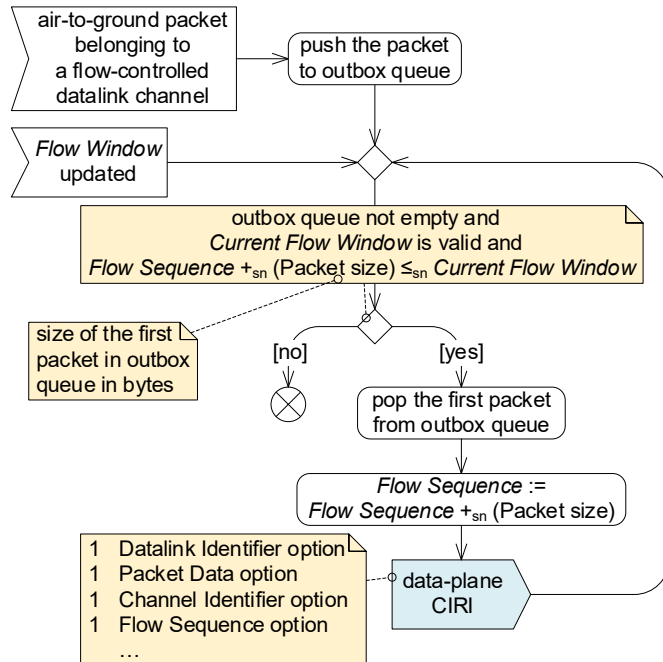

**Commented [FW115]:** Suggest rewording: "Instead, the packet should be kept in the "outbox" queue in the Airborne IPS System until the sufficient Flow Window update is received from the radio, or it should be processed in another way (e.g., discarded)."  
I intentionally omit sending the packet via another datalink, because this is not a universally good idea. Example: sending packet using LLAs over different datalink does not make any sense.

**Commented [JZ116R115]:** The text changed in the meantime.  
Also, the text is not trying to imply that all datalinks can be used to forward all packets, but forwarding a packet (that is not too old) via another datalink can be IMHO a valid option. And the Airborne IPS System must know which datalinks can be used to forward the packet anyways.

Figure 4-5 – Example Operation of the Airborne IPS System CIRI Endpoint Data Plane in the Air-Ground Direction with Flow Control

**Commented [FW117]:** In this figure: Recommendation: Move the text "[outbox queue not empty and current flow ...]" above the diamond box and label the outgoing arrows with "Yes"/"No". IMHO, this will increase readability a lot.

**Commented [JZ118R117]:** Diagram updated

4.5.2 Airborne Radio Flow Control Operation

For each flow-controlled datalink channel (see Section 4.4.1), the Airborne Radio keeps track of the *Highest Flow Sequence* and the *Current Flow Window*. These variables are initialized to "invalid". If these variables are not invalid, then the following invariant (INV) must hold:

$$\text{Highest Flow Sequence} \leq_{sn} \text{Current Flow Window} \quad (\text{INV})$$

For each flow-controlled datalink channel, all control-plane CIRI messages sent by the Airborne Radio contain one Flow Window option with the *Flow Window* field set to value of the *Current Flow Window* for that channel. If the *Current Flow Window* for that channel is invalid, then the *Flow Window* field is omitted (i.e., the Flow Window option has *Length* = 1).

After initialization, the Airborne Radio endpoint sends a control-plane CIRI message having a Flow Window option without the *Flow Window* field for each flow-controlled datalink channel.

4.0 CIRI PROTOCOL OPERATION

When the Airborne Radio:

- receives a Flow Sequence option in a control-plane CIRI message, or
- receives a Flow Sequence option in a data-plane CIRI message and the *Current Flow Window* for the datalink channel is invalid,

then the *Highest Flow Sequence* is set to the received *Flow Sequence* and the *Current Flow Window* variable is updated to a valid value, such that

$$\text{Highest Flow Sequence} +_{sn} (\text{size of the flow window}) = \text{Current Flow Window}.$$

The size of the flow window should use the lowest possible value, that does not impair datalink service performance.

When the Airborne Radio receives a Flow Sequence option for a flow-controlled data-plane CIRI message and the *Current Flow Window* for the channel has a valid value, and if:

$$\text{Highest Flow Sequence} \leq_{sn} (\text{Flow Sequence in the CIRI message})$$

Then the *Highest Flow Sequence* is set to the received *Flow Sequence*. At this point, if the invariant (INV) does not hold, then the *Current Flow Window* is set to the *Highest Flow Sequence*.

When the Airborne Radio receives a Flow Sequence option for a flow-controlled channel in a data-plane CIRI message and the *Current Flow Window* for the channel has a valid value, and if:

$$\text{Highest Flow Sequence} \leq_{sn} (\text{Flow Sequence in the CIRI message})$$

Then the *Highest Flow Sequence* is set to the received *Flow Sequence*. At this point, if the invariant (INV) does not hold, then the *Current Flow Window* is set to the *Highest Flow Sequence*.

At any time, the Airborne Radio may decide to extend (or shrink) the issued *Flow Window* for a datalink channel, by changing the *Current Flow Window* variable for the channel. When it does, it must send an unsolicited control-plane CIRI message with the updated information.

The Airborne Radio should extend the flow window and send the corresponding unsolicited CIRI message whenever it has resources available to handle additional air-to-ground traffic, e.g., because it has already transmitted some of the air-to-ground packets to the ground and released resources.

COMMENTARY

When the Airborne Radio decides to shrink the flow window, it must be prepared to handle out-of-sync data-plane CIRI messages that the Airborne IPS System transmitted according to the previously issued flow window.

4.5.3 Flow Control Example

Air-to-ground throughput of a SATCOM datalink depends on “time slots” assigned by the access network infrastructure, and assignment of the time slots is driven by amount of data queued in the SATCOM Airborne Radio. So, the Airborne Radio can try to keep its queues at some “watermark” level. This ensure, with some level of confidence, that the SATCOM datalink uses available resources optimally if there

**Commented [FW119]:** I understand that this is for the Flow Sequence option in the data plane message, where the size of the packet does not exceed the Current Flow Window. Do you think that this could be added as a clarification?

**Commented [FW120]:** Since IPS System and the Radio operate asynchronously and there is non-zero latency in CIRI session, what happens in the following scenario:

1. Radio decides to reduce the current flow window, and
2. Radio receives a number of packets that exceed the new reduced flow window value?

**Commented [JZ121R120]:** When the flow control is in effect, then the router can send to the radio only packets for which it already received “credits” (=Flow window). The Radio might revoke already issued credits by shrinking the Flow window, but then it must be of course able to handle the scenario you described. (commentary added to the text)

On the other hand, I believe that shrinking the Flow window will not be very common operation -- at least unless the radio does not handle some non-IPS traffic outside of the scope of the CIRI flow control.

## 4.0 CIRI PROTOCOL OPERATION

are any air-to-ground data, but also that the data are not queued in the radio unnecessarily.

In the example above, the *Flow Window* indicated by the Airborne Radio might be computed as

$$\text{Flow Window} := \text{Highest Flow Sequence} +_{sn} \max(0, \text{watermark}_0 + (\text{nominal\_throughput} \times \text{period}) - \text{queued\_data\_size})$$

where:

- *Highest Flow Sequence* is the highest *Flow Sequence* recently received from the Airborne IPS System for the given datalink channel
- $\text{watermark}_0$  is amount of data, that should be queued at any point of time to achieve optimal performance, e.g., to request all time slots available
- $\text{nominal\_throughput}$  is best-case throughput of the datalink
- $\text{period}$  is time between two consecution CIRI messages with the Flow Window options and
- $\text{queued\_data\_size}$  is amount of data already waiting for transmission in the Airborne Radio queues.

Commented [FW122]: Suggestion: remove "for example".

**ATTACHMENT 1  
LIST OF ACRONYMS**

**ATTACHMENT 1 LIST OF ACRONYMS**

A-G or A/G	Air-to-Ground
AEEC	Airlines Electronic Engineering Committee
AeroMACS	Aeronautical Mobile Airport Communications System
AGMI	Air-Ground Mobility Interface
AID	Aircraft Interface Device
AISD	Aircraft Information Services Domain
AOC	Airline or Aeronautical Operational Control
ATC	Air Traffic Control
ATS	Air Traffic Services
CIRI	Common IPS Radio Interface
COTS	Commercial Off The Shelf
CSP	Communication Service Provider
DLEP	Dynamic Link Exchange Protocol
DTIS	Digital Information Transfer System
FCI	Future Communications Infrastructure
FRD	Functional Requirements Document
G-G or G/G	Ground-to-Ground
ICAO	International Civil Aviation Organization
ID	Identifier
IEEE	Institute of Electrical and Electronics Engineers
IETF	Internet Engineering Task Force
IF	Interface
INV	Invariant
IP	Internet Protocol
IPS	Internet Protocol Suite
IPv4 / IPv6	Internet Protocol Version 4 or Version 6
L2	Layer 2
LDACS	L Band Digital Aeronautical Communication System
lsb/LSB	Least Significant Bit
MAGIC	Manager of Air-Ground Interface Communications
Max	Maximum
MDE	Multilink Decision Engine
MIB	Management Information Base
MIH	Media Independent Handover
msb/MSB	Most Significant Bit
MTU	Maximum Transmission Unit
OMNI	Overlay Multilink Network Interface
QoS	Quality of Service
RCP	Required Communication Performance

**ATTACHMENT 1  
LIST OF ACRONYMS**

RCTP	Required Communication Technical Performance
RF	Radio Frequency
RFC	Request for Comment
RSP	Required Surveillance Performance
SAP	Service Access Point
SATCOM	SATellite COMmunications
SB-Safety	Swift Broadband-Safety
SDO	Standards Development Organization
SESAR	Single European Sky Air Traffic Management (ATM) Research
SESAR JU	SESAR Joint Undertaking
Sn	Sequence Number
SNMP	Simple Network Management Protocol
TBC	To Be Confirmed
TBD	To Be Determined
TCP	Transmission Control Protocol
TLV	Type-Length-Value
UDP	User Datagram Protocol

**ATTACHMENT 2  
GLOSSARY**

**ATTACHMENT 2 GLOSSARY**

**Access Network**

A network that is characterized by a specific access technology. [Source: ICAO Doc. 9896]

**Air-Ground Access Network**

Access network that provides air-ground communication services.

**Air-Ground Datalink**

Refer to the definition for Air-Ground Access Network.

**Airborne IPS Host**

Airborne instantiation of an IPS Host.

**Airborne IPS Router**

An airborne device that is used to support ATN/IPS packet forwarding between one or more Airborne IPS Hosts and Airborne Radios.

**Airborne IPS System**

The collection of airborne components and functions that provide IPS services.

**Airborne Radio**

Physical airborne radio that provides the communication over-the-air using the specific air-ground access network specification and the Layer 2 interface to the Airborne IPS System.

**AMS(R)S – Aeronautical Mobile-Satellite Route Service**

An aeronautical mobile-satellite service reserved for communications related to safety and regularity of flights, primarily along national or international civil air routes. [Source: ICAO Annex 10, Volume II]

**AOC – Aeronautical Operational Control**

Communication required for the exercise of authority over the initiation, continuation, diversion or termination of flight for safety, regularity and efficiency reasons. [Source: ICAO Annex 10, Part III]

**AOC – Airline Operational Control**

Operational messages used between aircraft and airline dispatch centers or, by extension, the DoD to support flight operations. This includes, but is not limited to, flight planning, flight following, and the distribution of information to flights and affected personnel.

**ATN/IPS**

The set of technical provisions and standards that define the architecture and operation of Internet Protocol-based networking services. Also referred to as IPS.

**ATTACHMENT 2  
GLOSSARY**

**ATN/IPS Network / System**

Internetwork consisting of ATN/IPS nodes and networks operating in a multinational environment in support of Air Traffic Services (ATS) as well as aeronautical industry service communication such as Aeronautical Operational Control (AOC) and Aeronautical Administrative Communications (AAC).

**Control Plane**

Data exchanged to manage communication sessions between users. The control plane includes protocols providing information needed to move traffic from one device to another through the network. Routing protocols and DNS belong to the control plane.

**Data Plane**

The collection of resources across all network devices responsible for forwarding traffic to the next hop along the path to the selected destination network according to the control plane logic.

**Downlink**

A unit of data sent from an aircraft to a ground-based system.

**IPS (aka IPS for Safety Services)**

Refer to the definition for ATN/IPS.

**IPS Node**

A device that implements IPv6. There are two types of IPS nodes: an IPS Host and an IPS Router. Note: An IPS Gateway could be considered an IPS Node.

**IPS Router**

A node that forwards Internet protocol (IP) packets not explicitly addressed to itself. A router manages the relaying and routing of data while in transit from an originating IPS Host to a destination IPS Host. [Source: ICAO Doc. 9896]

**IPS System**

The IPS System is the all-encompassing aviation internet that provides data transport, networking, routing, addressing, naming, mobility, multilink and information security functions to the aviation services. The IPS System includes the Layer 3 and Layer 4 functions of the ISO/IEC 7498-1 OSI 7-layer Reference Model. The IPS System does not include the underlying subnetwork functions that provide connectivity or the applications. [Source: RTCA DO-379A and EUROCAE ED-262A]

**Link\_degraded**

A link technology-specific indication that link conditions are degrading, which may result in connection loss.

**Link\_down**

A discrete event indicating that a Layer 2 connection is broken and the link is unavailable.

**ATTACHMENT 2  
GLOSSARY**

**Link Local Address**

Link-Local addresses are for use on a single link. Link-Local addresses are designed to be used for addressing on a single link for purposes such as automatic address configuration, neighbor discovery, or when no routers are present.

**Link\_up**

A discrete event indicating that a Layer 2 connection is established and the link is available.

**Multilink**

Ability to use all available air-ground access networks in order to provide the specified performance.

**Network**

A group of two or more devices (nodes) that communicate using a common set of communication protocols.

**Network Layer**

Protocol layer based on Internet Protocol (IP) ensuring global routing over interconnected packet-switched communication networks.

**Physical and Link Layers**

Functions within the subnetworks that handle the physical interface with the transmission medium (i.e., radio links).

**QoS – Quality of Service**

A framework where the overall performance of an application or a computer network is stated. Some examples of parameters are: Integrity, Availability, Delay, Continuity, bit rate, throughput, delay, etc.

**Satcom – Satellite Communications**

Communication service providing data, voice, and fax transmission via satellite. Allows aircraft to communicate in BLOS areas.

**SESAR – Single European Sky ATM Research**

European air traffic control infrastructure modernization program. SESAR aims at developing the new generation ATM system capable of ensuring the safety and fluidity of air transport worldwide over the next 30 years.

**Subnetwork**

An actual implementation of a data network that employs a homogeneous protocol and addressing plan and is under control of a single authority. [ICAO Doc. 9705]

**Transport Layer**

Protocol layer used to provide reliable or unreliable communication services over the IPS System. Those include TCP for reliable transport services and UDP that is used to provide best effort service.



**ATTACHMENT 2  
GLOSSARY**

**Uplink**

A unit of data sent from a ground-based system to an aircraft.

APPENDIX A  
CIRI PROTOCOL BACKGROUND

APPENDIX A CIRI PROTOCOL BACKGROUND

The main body of this document provides the normative specification of the CIRI protocol for implementation by an Airborne IPS System and Airborne Radios. The informative material in this appendix should not be interpreted as normative and is provided solely as background information to explain the basis for the selection and characteristics of the CIRI protocol.

The information provided is based on work performed under the SESAR 14.2.4 project that summarized its results in Functional Requirements Document [FCI-FRD].

A-1 Common IPS Radio Interface Requirements

This section defines a set of requirements defining the needs of the Common IPS Radio Interface.

The following tables present control plane, data plane, flow control, and robustness requirements. Mandatory protocol requirements are identified using “shall” and recommendations are identified using “should” and italicized text.

Table A-1 – Control Plane Requirements

No.	Requirement	Note	CIRI Protocol Compliance
1	The Common IPS Radio Interface protocol <b>shall</b> enable the Airborne Radio to report datalink operational status to the Airborne IPS System.	At a minimum, distinguishing available (“link_up”) and not available (“link_down”).	Channel Status option
2	The Common IPS Radio Interface protocol <b>shall</b> be able to distinguish multiple different operational statuses.	For example, distinguishing between “link_up” and “link_degraded”.  Although defining a fine-grained metric that would allow comparing “fitness” of datalinks of various technologies proves to be extremely difficult, ability to indicate a non-nominal, degraded performance is considered to be useful.	Distinguishes up to 7 distinct operational statuses
3	The Common IPS Radio Interface protocol <b>shall</b> enable the Airborne Radio to report operational status separately for multiple datalink channels when multiple channels are provided by the datalink.	The “Channel” identifies a subset of air-to-ground traffic, that is treated by the Airborne Radio together.  This is necessary to support SATCOM operation described in Requirement 6, to distinguish status of the provided “higher-priority” (RCP/RSP-bound, e.g., ATS) and “lower-priority” (non-RCP/RSP-bound, e.g., AOC) channels.  An Airborne Radio may provide and announce just single datalink channel that will be used for all traffic.	Channel Status option  Allows reporting status for up to 255 channels.
4	The Common IPS Radio Interface protocol <b>shall</b> enable the Airborne Radio to report the current access network identifier.	This information is necessary for the mobility and multilink signaling (e.g., AGMI).	Link Instance option  The option is chosen such that the received Link Instance ID can

**Commented [SM123]:** [P3-M22-04 – M.Skorepa/Z.Jaron – HON]: (Tim B., Thales) State somewhere in the document that the radios do not need to implement ALL the features offered by the CIRI protocol (e.g., signaling status for multiple services vs. for a single service).

APPENDIX A  
CIRI PROTOCOL BACKGROUND

No.	Requirement	Note	CIRI Protocol Compliance
		<p>The "access network" identifies a combination of the datalink technology and a communication service provider.</p> <p>For example, a Link Instance ID as defined in the AGMI protocol. This information might be also important for multilink selection in the aircraft.</p>	be used directly in the AGMI protocol.

Table A-2 – Data Plane Requirements

No.	Requirement	Note	CIRI Protocol Compliance
5	The Common IPS Radio Interface protocol shall enable the Airborne Radio and the Airborne IPS System to exchange data-plane packets not exceeding 1280 bytes. Larger packets may be supported.	<p>In other words, the minimum MTU size of the data plane of the Common IPS Radio Interface must be 1280 bytes or larger.</p> <p>For this basic requirement, no special protocol would be needed.</p>	Data-Plane message with Packet Data option
6	The Common IPS Radio Interface protocol shall enable the Airborne IPS System to indicate a datalink channel for air-to-ground packets passed to the Airborne Radio.	<p>This is needed for safety-certified datalink operation, that can simultaneously handle RCP/RSP-bound communication (higher priority/"ATS" traffic) and communication without RCP/RSP constraints (lower priority/"AOC" traffic).</p> <ul style="list-style-type: none"> <li>The higher priority traffic needs this to satisfy the RCP/RSP even in the presence of the uncontrolled traffic.</li> <li>For example, satcom is envisioned to provide dedicated underlying channels for the higher priority traffic and the lower priority traffic.</li> </ul> <p>The requirement could be satisfied by deploying multiple non-CIRI-based data-plane interfaces between the Airborne IPS System and the Airborne Radio.</p>	Channel Identifier option

**Commented [SM124]:** [P3-M22-05 – M.Skorepa/Z.Jaron – HON]: Revisit the wording to explain that 1280 is the minimum, not maximum

**Commented [SM125]:** [P3-M22-06 – M.Skorepa/Z.Jaron – HON]: Should the requirement address a protocol requirement for a minimum number of services? Recommend including a note that currently we are considering Radios that support two services; add similar note Section 5.2.

Note that although the Requirements 5 and 6 and could be satisfied by one or several "plain" interfaces/channels for the data-plane packets; however, the Common IPS Radio Interface defines a more scalable and extensible alternative, in form of the data-plane CIRI message.

Table A-3 – Flow Control Requirements

No.	Requirement	Note	CIRI Protocol Compliance
7	The Common IPS Radio Interface protocol shall enable the Airborne Radio to inform	The "flow" is a subset of air-to-ground traffic. See Requirements 8 and 9.	Flow control mechanism

APPENDIX A  
CIRI PROTOCOL BACKGROUND

No.	Requirement	Note	CIRI Protocol Compliance
	the Airborne IPS System about the number of bytes that it can accept in a flow.		
8	The Common IPS Radio Interface protocol <b>shall</b> support multiple flows, where each flow consists of air-to-ground packets belonging to a single channel (as described in Requirement 3).	I.e., the protocol can provide flow control on a per- channel basis	Flow control mechanism
9	<i>The Common IPS Radio Interface protocol <b>should</b> support a flow that consist of all air-to-ground packets (regardless of the channel).</i>	I.e., the protocol can provide flow control for all traffic together.	None. This optional feature was not included to simplify the flow control mechanism.

The operation of the flow control mechanism is also influenced by the following Robustness requirements.

Table A-4 – Robustness Requirements

No.	Requirement	Note	CIRI Protocol Compliance
10	The Common IPS Radio Interface protocol <b>shall</b> be robust against:		Flow control and/or stateless operation of the CIRI protocol
10.1	... Airborne IPS System restarts (losing its Common IPS Radio Interface-related runtime state)		
10.2	... Airborne Radio restarts (losing its Common IPS Radio Interface-related runtime state)		
10.3	... interleaved messages in opposite directions.	Case shown in the following diagram: 	
11	<i>The Common IPS Radio Interface protocol <b>should</b> be robust against change of message delivery order.</i>	This is assumed to be much a much less probable situation than the one described in Requirement 10.3.	CIRI protocol converges to a valid state with the next received CIRI message
12	The Common IPS Radio Interface protocol <b>shall</b> allow future backward compatible extensions, that will interoperate with implementations of the older protocol version.		CIRI header contains 3 reserved bits that are ignored by older implementations New CIRI TLV options can be defined, which

**APPENDIX A**  
**CIRI PROTOCOL BACKGROUND**

No.	Requirement	Note	CIRI Protocol Compliance
			will be ignored by the older implementations.  Most current CIRI options can be extended. The extra bytes will be ignored by the older implementations.  CIRI options used in cases with undefined semantics are ignored.
13	The Common IPS Radio Interface protocol <b>shall</b> allow future non-backward compatible versions.		CIRI header Version field will be incremented if this becomes necessary

**Table A-5 – General Protocol Operation Requirements**

No.	Requirement	Note	CIRI Protocol Compliance
14	The Common IPS Radio Interface protocol <b>shall</b> enable the Airborne IPS Systems to have up-to-date datalink status information from the Airborne Radio.	The "datalink status information" is defined by requirements in Section 4.3.1.	CIRI request-response communication pattern allows the Airborne IPS System to fetch the current information after startup.  CIRI "trap-like" unsolicited messages sent by the Airborne Radio convey changes in datalink status information without a delay.
15	The Common IPS Radio Interface protocol <b>shall</b> enable the Airborne IPS System to detect loss of connection with the Airborne Radio.	This "health monitoring" detects when the radio goes down or when the connection between the Airborne IPS System and the Airborne Radio is broken.	CIRI protocol assumes the Airborne Radio is "broken" if answers to consecutive requests are not received.

## A-2 Protocol Design Principles

The following bullets define key design principles for a Common IPS Radio Interface Protocol:

- The protocol should be as simple as possible.
  - Facilitates certification
  - Facilitates implementation
- The protocol should be as stateless as possible.
  - Facilitates recovery after restart of either peer.

**APPENDIX A  
CIRI PROTOCOL BACKGROUND**

- The protocol should not need any information from the lower layers (e.g., IP address, UDP port) to distinguish messages for/from different datalinks.

**A-3 Candidate Protocol Alternatives – Initial Assessment**

The following alternatives were considered as implementation options for the Common IPS Radio Interface protocol.

**A-3.1 Custom Layer 2 Protocol**

Common IPS Radio Interface messages are implemented using a simple custom protocol that is carried directly by layer 2 (L2) frames (e.g., Ethernet) with no IP layer involved.

The main benefit of this approach is that it is lightweight – the Airborne Radio would not need an IPv6 network stack implementation. However, this approach is very nonstandard in the “TCP/IP” protocol suite, and consequently, this is the only alternative that does not use either a TCP/IP or UDP/IP stack.

**A-3.2 SNMP**

This protocol is a de-facto industry standard, but it is (despite its name) rather complex and heavyweight. It offers plenty of configurable features (e.g., fine-grained access control, discovery procedure) while the Common IPS Radio Interface would only benefit from several specialized types of messages periodically sent between the peers.

To use SNMP for the Common IPS Radio Interface, it is necessary to know MIB and “operational protocol” – which party sends which message at which occasion, usage of SNMP requests/traps &c.

There are basically two options:

- Each radio uses its own MIB with its own semantics
  - This is simple, as there is nothing to standardize.
  - On the other hand, this approach leaves fundamental parts of the Common IPS Radio Interface operation unspecified. A considerable amount of radio-specific configuration, and possibly adaptation layer software, is needed for each radio
  - Because this approach does not result in a “standardized Common IPS Radio Interface”, it is not further investigated in this document.
- There is a common MIB and standardized mode of operation supported by all compliant radios.
  - This is the preferred approach when using SNMP
  - The following must be standardized:
    - Common IPS Radio Interface MIB
    - SNMP configuration for Common IPS Radio Interface, e.g., configuration of security model
    - Common IPS Radio Interface “operational protocol.”

Consequently, defining the Common IPS Radio Interface protocol on top of SNMP still necessitates further definition and standardization.

**APPENDIX A**  
**CIRI PROTOCOL BACKGROUND**

**A-3.3 ARINC 839 MAGIC**

Although ATN/IPS is not a MAGIC-complaint system per ARINC 839, the Common IPS Radio Interface bears some similarities to the Common Link Interface specified in ARINC 839.

- The Common Link Interface is based on MIH\_LINK\_SAP from IEEE 802.21, which is not designed to operate between different nodes over a network.
- There is not any standard way to transfer MIH\_LINK\_SAP primitives over a network; however, IEEE 802.21 defines structure of MIH\_LINK\_SAP primitives and a serialization into a stream of octets.
- MIH\_LINK\_SAP primitives are quite complex and hold lots of information. Only a fraction of included information has been identified to bring a benefit to ATN/IPS environment.
- The purpose of MIH\_LINK\_SAP seems not to align with ATN/IPS needs well.
  - The MIH\_LINK\_SAP primitives are focused on commanding and controlling the “Data Link Module”
  - Common IPS Radio Interface is used only to retrieve information about a datalink.

Note that any implementation of Common IPS Radio Interface messages can be treated as an implementation of a subset of MIH\_LINK\_SAP primitives (Link\_Up, Link\_Down, etc.).

**A-3.4 TCP-based Data Plane Protocol**

TCP was evaluated as an option for flow-control capable data plane for the Common IPS Radio Interface. TCP is quite complex and provides unnecessary functionality, like congestion control and retransmissions. Although there are COTS implementations ready, the complexity would probably make the certification difficult.

Since TCP is stream-oriented protocol, it would be necessary to define how the stream is constructed from and then split into a sequence of data-plane packets. This is a minor issue, but it highlights complexity of addressing this for Common IPS Radio Interface unnecessary functionality of the TCP.

The COTS TCP flow control is driven purely by the receiver application (e.g., Airborne Radio) reading the packets from TCP queues. This would probably need to be changed, because the Airborne Radio needs to have a better control of the flow window provided to the Airborne IPS System.

Additionally, at the transmitting endpoint, if a COTS implementation is to be used, the data waiting for a flow window are stored in the queues of the TCP implementation and out of control of the transmitter (e.g., Airborne IPS System), preventing implementation of most of the envisioned benefits of the flow control, such as rerouting and fine-grained prioritization within the Airborne IPS System.

**A-3.5 Custom UDP-based Protocol – Common IPS Radio Interface Protocol (CIRI)**

Common IPS Radio Interface messages are implemented using a simple custom protocol that is carried by UDP/IP. UDP adds little overhead in comparison to just IPv6 stack and provides a standard way to transport data payload.

**APPENDIX A  
CIRI PROTOCOL BACKGROUND**

The proposed protocol is simple and easy to implement. It is designed to be future-proof and can be easily extended with new “options.” While this requires the need to specify a new protocol, all of the other candidate protocols would also need a new standard (or a “profile”) specifying how the particular protocol should be used to satisfy identified requirements.

**A-3.6 Candidate Protocol Summary**

The following table provides a summary comparison of the candidate protocols described in this section.

**Table A-6 – Protocol Comparison Matrix**

Criteria	SNMP	MAGIC	Custom L2	TCP	Custom UDP (CIRI)
Control plane support	Yes	Yes	Yes	No	Yes
Data plane support	No	No	Yes	Yes	Yes
COTS layers	(L2) IPv6 UDP SNMP	(L2) IPv6 UDP or TCP	(L2)	(L2) IPv6 TCP (modified)	(L2) IPv6 UDP
To be specified / standardized	Operation, MIB	Transport, operation	Transport, operation, message format	Operation	Transport, operation, message format
To be implemented	Operation, MIB	Operation	Operation, message format	TCP modifications	Operation, message format
Protocol complexity	High	High	Low	High	Low
Approach commonality	High	Medium	Low	High	Medium
Certification complexity	High	High	Medium	High	Medium

Although the transport, operation, and message format must be specified for the Custom UDP (CIRI) protocol, the low protocol complexity also minimizes the complexity of the standardization effort, as conveyed in the body of this document.

**A-4 Candidate Protocol Alternatives – Secondary Assessment**

Subsequent to the candidate assessment presented in A-3, the Dynamic Link Exchange Protocol (DLEP), per RFC 8175, was also assessed as a potential radio interface protocol. DLEP is designed to communicate datalink characteristics between a “modem” and a “router,” which matches the nature of the Common IPS Radio Interface. However, it diverges somewhat from needs of the IPS. For example:

- DLEP assumes the possibility of multiple “destinations” directly reachable through the managed datalink, and datalink characteristics can be specified per-destination.
- DLEP can be used to indicate IP addresses and subnets assigned to destinations, possibly replacing Neighbor Discovery on the link.
- DLEP also supports plug-and-play style deployment, where the router can discover modems and then the peers negotiate used parameters for DLEP session.

Because DLEP, including standardized extensions, does not elegantly provide all features per the Common IPS Radio Interface requirement, an option of using DLEP with a custom extension is also evaluated.



**APPENDIX A**  
**CIRI PROTOCOL BACKGROUND**

**A-4.1 Comparison Overview**

The following tables compare characteristics and the ability to meet the CIRI requirements specified in Section A-1 of this appendix.

**Table A-7 – Basic Characteristics**

Characteristic	Custom UDP (CIRI)	DLEP (COTS)	DLEP + custom extensions
Peering	Preconfigured	Possibly plug-and-play	Possibly plug-and-play
Transport	UDP	TCP	TCP
COTS	No	Yes	No

**Table A-8 – Ability to Meet CIRI Requirements**

Requirement per Section A-1		Custom UDP (CIRI)	DLEP (COTS)	DLEP + custom extensions
No.	Short Description			
1	Report datalink operational status	Yes	Yes	Yes
2	Multiple different operational statuses	Yes (7)	Yes (99)	Yes (99)
3	Separate operational status for multiple datalink channels	Yes	Only using ugly hacks	Yes (custom extension needed)
4	Report current access network identifier	Yes	No	Yes (custom extension needed)
5, 6	Data plane	Yes	No	No
7	Flow control	Yes	Yes (only pause/resume)	Yes (only pause/resume)
8	Flow control: flow per datalink channel	Yes	Only using ugly hacks	Yes (custom extension needed)
9	[optional] Flow control: one universal flow	No	Yes	Yes
10.1, 10.2	Robustness against restarts	Yes	Yes	Yes
10.3	Robustness against interleaved messages in opposite directions	Yes	Yes	Yes
11	[optional] Robustness against change of message delivery order	Partial	Yes	Yes
12	Support for future backward compatible extensions	Yes	Yes	Yes
13	Support for future non-backward compatible versions	Yes	Yes	Yes
14	Timely delivery of status information	Yes	Yes	Yes
15	Radio health monitoring	Yes	Yes	Yes

**A-4.2 DLEP Profile for the Common IPS Radio Interface**

In the context of DLEP, the Airborne Radio is a DLEP “modem,” and the Airborne IPS System is a DLEP “router.”

**A-4.2.1 Signaling Datalink Status (Requirements 1 and 2)**

The Airborne Radio indicates, in the Session Initialization Response Message and in subsequent Session Update Messages, datalink status using DLEP Data Items Relative Link Quality (Receive) and Relative Link Quality (Transmit). Relative Link Quality 0 indicates “datalink not operational”, other values indicate “datalink operational.” Relative Link Quality 100 should indicate the nominal operational

**APPENDIX A  
CIRI PROTOCOL BACKGROUND**

performance ("link\_up"), other values can be used for non-nominal performance (e.g., "link\_degraded").

**A-4.2.2 Signaling Status for Multiple Datalink Channels (Requirement 3)**

DLEP, including currently standardized extensions, does not provide a clean way to signal separate sets of parameters for multiple channels provided by the datalink. Several options are described in the following sub-sections.

**A-4.2.2.1 Option 1: Separate DLEP Sessions**

One option is to establish a dedicated DLEP session for each channel, effectively treating them as separate datalinks. This is probably the cleanest option achievable with currently standardized DLEP, but this approach has a significant impact on Mobility and Multilink signaling (i.e., the AGMI protocol).

**A-4.2.2.2 Option 2: Abusing DLEP Destinations**

Another option would be to treat datalink channels as DLEP "destinations" and signal the *Relative Link Quality* for these destinations. DLEP destinations are identified using MAC addresses, so it would be necessary to define a special MAC address for each supported datalink channel. Alternatively, channel-specific destinations might use single common MAC address in combination with channel-specific Link Identifier as introduced by the DLEP Link Identifier Extension.

**A-4.2.2.3 Option 3: Custom DLEP Extension**

Third option would be to develop a custom DLEP extension, that would define, for example, the following new channel-specific messages to signal relative link quality:

- Channel Up Message
- Channel Up Response Message
- Channel Update Message
- Channel Update Response Message
- Channel Down Message
- Channel Down Response Message
- Channel Identifier Data Item (present in every Channel \* Message)

This option may be best, but it defeats the benefit of using a COTS protocol.

**A-4.2.3 Reporting Auxiliary Information (Requirement 4)**

DLEP does not provide a way to communicate auxiliary datalink information as is Access network identifier (Link instance ID) or Datalink Context. However, it would be straightforward do define a DLEP extension to convey such information.

**A-4.2.4 Data Plane (Requirements 5 and 6)**

DLEP is not intended to handle data-plane traffic, so another interface must be used for data plane. Note that the data plane must identify a "datalink channel" for each air-to-ground data-plane packet.

**A-4.2.5 Flow Control (Requirements 7, 8, and 9)**

The Control-Plane-Based Pause DLEP Extension (per RFC 8651) provides a simple flow control mechanism. The Airborne Radio declares a set of "queues," where each queue is defined by a set of DSCPs, and at any point in time, the Airborne Radio

## APPENDIX A CIRI PROTOCOL BACKGROUND

can instruct the Airborne IPS System to “pause” data-plane flow for any declared queue. The “pause” instruction can be issued for the entire DLEP session, or per DLEP destination. So, this mechanism is compatible with both Option 1 and Option 2 described in Sections A-4.2.2.1 and A-4.2.2.2, respectively.

Note that although this mechanism might be sufficient, it is subject to some race conditions, e.g., the radio might receive some data-plane packets after sending the pause message. For comparison, flow control in CIRI allows the Airborne Radio to indicate how much data (in bytes) the radio can accept from the Airborne IPS System, ensuring that the Airborne Radio will never receive more air-to-ground data that it is willing to handle.

### A-4.2.6 Robustness (Requirements 10, 11, 12, and 13)

Because the DLEP uses TCP connection, then restart of any peer inherently leads to establishment a new DLEP session. TCP also prevents ordering issues within the DLEP session. On the other hand, because the data plane is not handled by DLEP, there are still some possible outstanding ordering issues (see the race condition described in Section A-4.2.5.)

DLEP uses TLV to encode information (similar to the CIRI protocol) providing sufficient room for future backwards-compatible extensions. DLEP also employs an extension negotiation procedure at the beginning of every DLEP session. Although this increases the complexity of the protocol implementation, it may further facilitate incremental deployment of future extensions.

### A-4.2.7 General Operation (Requirements 14 and 15)

The Airborne Radio sends a DLEP message (Session Update Message or another, see Section 3.2) immediately after detecting change of datalink status, ensuring the timely delivery of the status information. In absence of other messages, DLEP endpoints periodically send a Heartbeat Message, enabling detection of loss of a DLEP peer.

### A-4.3 DLEP Comparison Summary

The Common IPS Radio Interface protocol, as specified in the main body of this document, is recommended over DLEP. The rationale for this recommendation includes:

- DLEP uses TCP transport, and there have been strong objections against specifying the use of TCP for IPS, particularly in the avionics implementations (e.g., similar discussion regarding Enrolment over Secure Transport protocol for certificate enrolment)
- A COTS instance of DLEP does not fully meet the Common IPS Radio Interface requirements; therefore, custom extensions are necessary to address the gaps
- DLEP with custom extensions detracts from the attractiveness of being a COTS solution
- Compared to the DLEP, the CIRI protocol is simple and lightweight, which is especially attractive for the Airborne Radio implementation
- As part of IPS prototyping and validation activities, the CIRI protocol has been implemented by multiple Airborne Radio suppliers and validated in both the lab environment as well as during flight tests.

APPENDIX A  
CIRI PROTOCOL BACKGROUND

<END>

