

Reference planes

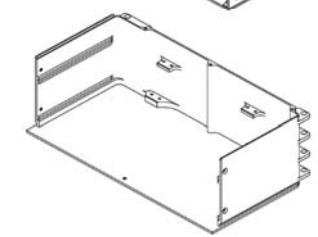

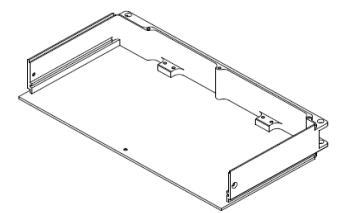
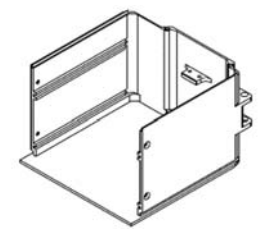
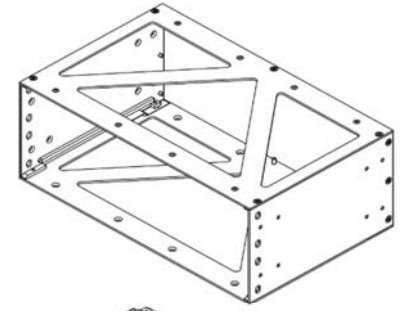
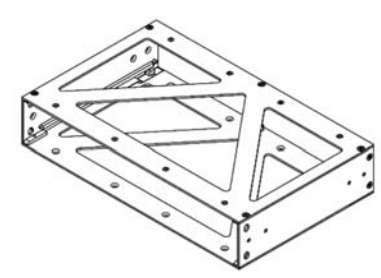
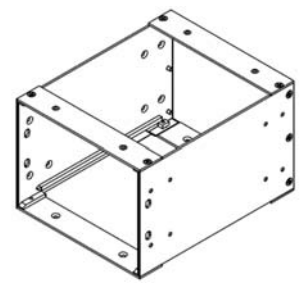
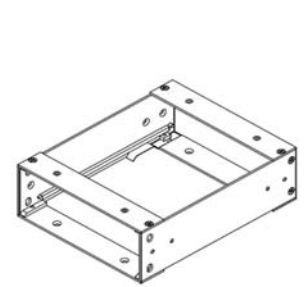
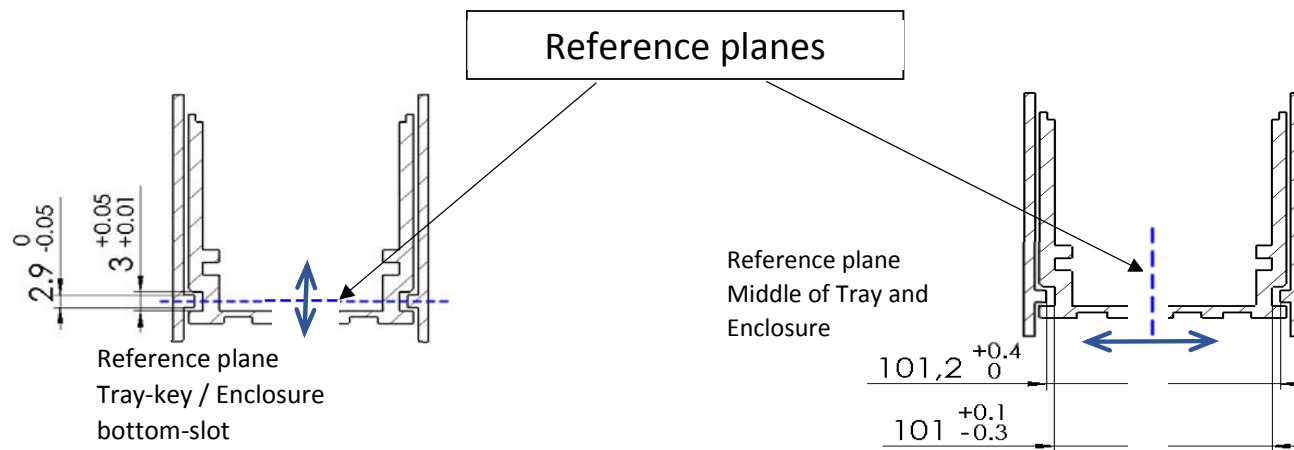

The tolerances for connector positions in back plate of enclosure and tray should not be taken into account.

We only considered the tolerances of max. movement (space) enclosure in tray.