

**ARINC SPECIFICATION 858 PART 3
TABLE OF CONTENTS**

1.0	INTRODUCTION.....	1
1.1	Purpose 1.....	
1.2	Scope 1.....	
1.3	Document Overview.....	1
1.3.1	Multi-Part Specification Organization.....	1
1.3.2	Part 1 Document Organization.....	1
1.3.3	Document Conventions.....	2
1.4	Related Documents.....	3
1.4.1	Relationship of this Document to Other ARINC Standards.....	3
1.4.2	Relationship to Other Industry Standards.....	3
1.5	Regulatory Approval.....	4
2.0	CIRI PROTOCOL DESCRIPTION.....	5
2.1	Use Case.....	5
2.2	Functional Description.....	6
2.3	Interface Description.....	7
2.4	Basic Communication Patterns.....	8
2.4.1	Control Plane.....	8
2.4.2	Data Plane.....	9
2.5	Flow Control Mechanism Description.....	9
2.6	Airborne Radio Reference Model.....	11
3.0	CIRI PROTOCOL MESSAGE STRUCTURE.....	13
3.1	Message Format.....	13
3.2	Option Format.....	13
3.3	Message Option Specification.....	15
3.3.1	Datalink Identifier Option.....	15
3.3.2	Link Instance Option.....	16
3.3.3	Channel Status Option.....	16
3.3.4	Flow Sequence Option.....	17
3.3.5	Flow Window Option.....	18
3.3.6	Packet Data Option.....	19
3.3.7	Channel Identifier Option.....	19
3.3.8	Expiration Time Option.....	20
3.3.9	Packet Type Option.....	20
3.3.10	ICAO Address Option.....	21
4.0	CIRI PROTOCOL OPERATION.....	22
4.1	Transport Requirements.....	22
4.1.1	General.....	22
4.1.2	Considerations for UDP-based Transport.....	22
4.2	Channels.....	23
4.3	Airborne IPS System CIRI Endpoint Operation.....	24
4.3.1	Configuration.....	24
4.3.2	Control Plane Operation.....	25
4.3.2.1	CIRI Control Plane Message.....	26
4.3.3	Status Processing.....	26
4.3.4	Data Plane Operation.....	27
4.3.4.1	CIRI Data Plane Message.....	27
4.4	Airborne Radio CIRI Endpoint Operation.....	28
4.4.1	Configuration.....	28
4.4.2	Control Plane Operation.....	28
4.4.2.1	CIRI Control Plane Message.....	29

Style Definition: Glossary Term

Style Definition: Acronym List

Style Definition: TOC 1: Space After: 0.02 line, Tab stops: 1.25", Left

Style Definition: TOC 2: Space Before: 0.02 line

Style Definition: Attachment HEADING 1

**ARINC SPECIFICATION 858 PART 3
TABLE OF CONTENTS**

4.4.2.2	CIRI Control Plane Performance Requirements	29
4.4.3	Data Plane Operation	30
4.4.3.1	CIRI Data Plane Message	30
4.5	Flow Control	30
4.5.1	Airborne IPS System Flow Control Operation	31
4.5.2	Airborne Radio Flow Control Operation	33
4.5.3	Flow Control Example	34
ATTACHMENT 1 LIST OF ACRONYMS		36
ATTACHMENT 2 GLOSSARY		38
APPENDIX A CIRI PROTOCOL BACKGROUND		41
A-1	Common IPS Radio Interface Requirements	41
A-2	Protocol Design	45
A-2.1	Key Principles	45
A-2.2	Flow Control Design Background	45
A-3	Candidate Protocol Alternatives – Initial Assessment	46
A-3.1	Custom Layer 2 Protocol	46
A-3.2	Simple Network Management Protocol (SNMP)	46
A-3.3	ARINC 839 MAGIC	47
A-3.4	TCP-based Data Plane Protocol	47
A-3.5	Custom UDP-based Protocol – Common IPS Radio Interface Protocol (CIRI)	48
A-3.6	Candidate Protocol Summary	48
A-4	Candidate Protocol Alternatives – Secondary Assessment	48
A-4.1	Comparison Overview	49
A-4.2	DLEP Profile for the Common IPS Radio Interface	50
A-4.2.1	Signaling Datalink Status (Requirements 1 and 2)	50
A-4.2.2	Signaling Status for Multiple Datalink Channels (Requirement 3)	50
A-4.2.2.1	Option 1: Separate DLEP Sessions	50
A-4.2.2.2	Option 2: Abusing DLEP Destinations	50
A-4.2.2.3	Option 3: Custom DLEP Extension	50
A-4.2.3	Reporting Auxiliary Information (Requirement 4)	51
A-4.2.4	Data Plane (Requirements 5 and 6)	51
A-4.2.5	Flow Control (Requirements 7, 8, and 9)	51
A-4.2.6	Robustness (Requirements 10, 11, 12, and 13)	51
A-4.2.7	General Operation (Requirements 14 and 15)	51
A-4.3	DLEP Comparison Summary	52

1.0 INTRODUCTION

1.0 INTRODUCTION

1.1 Purpose

As described in ARINC 858 Part 1, the Airborne Internet Protocol Suite (IPS) System must provide a datalink adaptation function to accommodate existing radio-specific interfaces. Although these radio-specific interface specifications are well-established within the respective radio standards, it is envisioned that ARINC Standards may need to evolve to accommodate IPS services. As these updates occur, there is an opportunity to harmonize the radio interface protocol and minimize the need for radio-specific adaptations in the Airborne IPS System.

The Common IPS Radio Interface (CIRI) protocol specified in this standard is intended to facilitate this harmonization by providing a standardized means to exchange status and information in a manner that allows different Airborne Radios to assess/present link status and to manage the flow of information consistent with the radio's abilities. Therefore, the CIRI protocol should be adopted, by reference to this standard, as the radio standards are updated.

1.2 Scope

This document serves as an ARINC standard to define a Common IPS Radio Interface (CIRI) protocol for conveying radio status information and for transferring digital data between the Airborne IPS System and Airborne Radios. This standard includes the functional description of the protocol including applicable use cases, protocol message formats, and protocol operation for both control plane and data plane exchanges. The protocol is intended to operate over a variety of on-aircraft communication means including, but not limited to, ethernet-based and ARINC 664-based aircraft networks.

1.3 Document Overview

1.3.1 Multi-Part Specification Organization

ARINC 858 is published as a multi-part document specification that includes the following documents:

- Part 1 – Airborne IPS System Technical Requirements
- Part 2 – IPS Gateway Air-Ground Interoperability
- Part 3 (*this document*) – Common IPS Radio Interface (CIRI) Protocol

1.3.2 Part 1 Document Organization

This document is organized as follows:

- Section 1.0 – Introduction
This section introduces the purpose and scope of this document, identifies related reference documents, and provides guidance for regulatory compliance.
- Section 2.0 – CIRI Protocol Description
This section provides an overview of the protocol use case, and it describes the protocol functions, interfaces, basic communication patterns for control-plane and data-plane message exchanges, and flow control mechanism. It also presents a notional Airborne Radio architecture that provides context for CIRI protocol functions.

1.0 INTRODUCTION

- Section 3.0 – CIRI Protocol Message Structure
This section defines the CIRI protocol message format and the format and content of message options.
- Section 4.0 – CIRI Protocol Operation
This section describes the transport mechanism requirements, how datalink channels are used, configuration of the Airborne IPS System and Airborne Radio CIRI endpoints, and the CIRI protocol operation for the exchange of control-plane messages and data-plane messages.
- Attachment 1 – List of Acronyms
This attachment provides a list of acronyms used in this document.
- Attachment 2 – Glossary
This attachment explains the precise meaning of terms used in this document to avoid ambiguity and confusion.
- Appendix A – CIRI Protocol Background
This appendix provides background information that explains the basis for the selection and characteristics of the CIRI protocol defined in the main body of this specification.

To assist readers with navigating this document, the following figure is an illustrative guide to the document sections and the relationships among the sections.

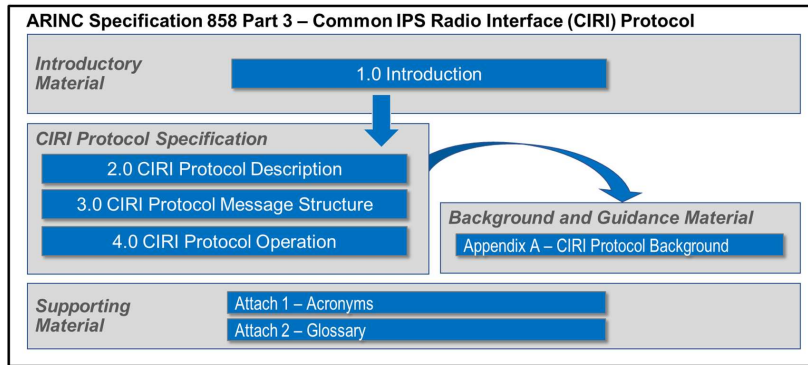

Figure 1-1 – Guide to ARINC Specification 858 Part 3

1.3.3 Document Conventions

The following table defines requirement statement conventions used throughout this document:

Table 1-1 – Requirement Statement Conventions

Term	Usage
shall or must	Mandatory requirement necessary for minimum conformance with this specification
should	Recommendation, the inclusion of which is advised but not required in order to conform to the specification.
may	Optional requirement, the inclusion of which is left to the implementer

1.0 INTRODUCTION

1.4 Related Documents

When avionics systems and subsystems are designed to use the capabilities provided by this specification, they should incorporate the provisions of this specification by reference. References to this specification should assume the application of the latest applicable version.

1.4.1 Relationship of this Document to Other ARINC Standards

ARINC Standards related to this specification are listed below, and the reader should ascertain the latest applicable published version.

ARINC Specification 429: *Digital Information Transfer System (DITS)*

ARINC Specification 664: *Aircraft Data Network*

ARINC Characteristic 750: *VHF Data Radio*

ARINC Characteristic 763A: *Mark 2 Network Server System (NSS) Form and Fit Definition*

ARINC Characteristic 766: *Aeronautical Mobile Airport Communication System (AeroMACS) Transceiver and Aircraft Installation Standards*

ARINC Characteristic 771: *Low-Earth orbiting Aviation Satellite Communication System*

ARINC Characteristic 781: *Mark 3 Aviation Satellite Communication System*

ARINC Characteristic 791: *Mark 1 Aviation Ku-band and Ka-band Satellite Communication System*

ARINC Characteristic 792: *Second-Generation Ku-band and Ka-band Satellite Communication System*

ARINC Specification 822A: *On-ground Aircraft Wireless Communication*

ARINC Specification 839: *Function Definition of Airborne Manager of Air-Ground Interface Communications (MAGIC)*

ARINC Specification 858: *Internet Protocol Suite (IPS) for Aeronautical Safety Services, Part 1, Airborne IPS System Technical Requirements*

1.4.2 Relationship to Other Industry Standards

The following list identifies related industry documentation referenced in this document. The version cited was available at the time of this writing, and the reader should ascertain the latest applicable published version.

EUROCAE

- **ED-262A:** *Technical Standard of Aviation Profiles for Internet Protocol Suite.* Also published as RTCA DO-379A.

International Civil Aviation Organization (ICAO)

- **ICAO Doc. 9896 Ed. 3:** *Manual for the Aeronautical Telecommunication Network (ATN) using Internet Protocol Suite (IPS) Standards and Protocols*

Institute of Electrical and Electronics Engineers (IEEE)

- **IEEE 802.21-2008:** *IEEE Standard for Local and Metropolitan Area Networks – Part 21: Media Independent Handover Services*

1.0 INTRODUCTION

Internet Engineering Task Force (IETF)

Note: Rather than referencing all IETF Request For Comments (RFCs) directly, this document refers to EUROCAE ED-262A and RTCA DO-379A, Internet Protocol Suite Profiles, which reference IETF RFCs relevant to specification of the IPS network stack. This approach minimizes changes to this document as IETF RFCs evolve over time.

- **RFC 1982:** *Serial Number Arithmetic*
- **RFC 8175:** *Dynamic Link Exchange Protocol (DLEP)*
- **RFC 8651:** *Dynamic Link Exchange Protocol (DLEP) Control-Plane-Based Pause Extension*
- **RFC 8703:** *Dynamic Link Exchange Protocol (DLEP) Link Identifier Extension*

RTCA

- **DO-379A:** *Technical Standard of Aviation Profiles for Internet Protocol Suite.* Also published as EUROCAE ED-262A.

Single European Sky Air Traffic Management Research Joint Undertaking (SESAR JU)

- **[FCI-FRD]:** *Future Communications Infrastructure (FCI) Functional Requirements Document (FRD), SESAR2020 PJ14-02-04 deliverable D5.2.010, Edition 00.00.07, 2018.*

1.5 Regulatory Approval

Compliance with this standard, in and of itself, does not ensure regulatory approval. Implementers are urged to obtain all information necessary for regulatory approval and work in close coordination with the appropriate regulatory authorities to gain certification as applicable.

2.0 CIRI PROTOCOL DESCRIPTION

2.0 CIRI PROTOCOL DESCRIPTION

2.1 Use Case

Existing Airborne Radios that are candidates to support IPS present a variety of radio-specific interface definitions with little-to-no commonality. Having heterogeneous Airborne Radio interfaces creates a diverse environment where the Airborne IPS System must adapt to the various radio-specific interfaces, each of which do not provide the same information or capabilities.

The CIRI protocol provides a unified and extensible approach for interfacing the Airborne IPS System with IPS-enabled Airborne Radios to support the needs of IPS, particularly in terms of multilink and Quality of Service (QoS). As illustrated in [Figure 2-1](#), and in accordance with the interface labeling conventions used in Section 3.7 of ARINC 858 Part 1, the CIRI protocol implements the Airborne IPS System external interface IF-4C, which handles data flows to and from IPS-enabled Airborne Radios, as well as radio status signaling to the Airborne IPS System.

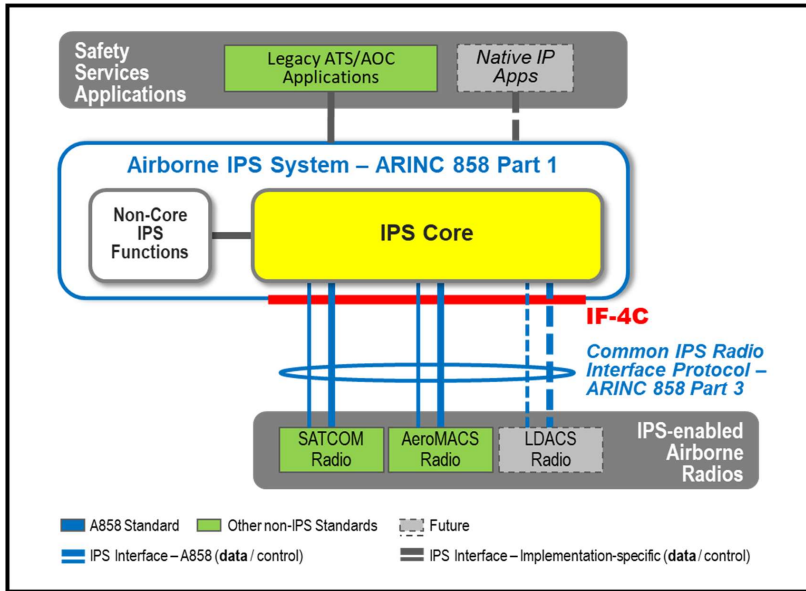

Figure 2-1 – Common IPS Radio Interface

As shown in the figure, the CIRI protocol specifically targets IPS-enabled Airborne Radios; throughout this document, instances of Airborne Radio should be interpreted as meaning an IPS-enabled Airborne Radio. As summarized in the following table, the CIRI protocol is optional for IPS-enabled Airborne Radios; when CIRI is not an available radio interface option, then the Airborne IPS System must provide adaptation of radio-specific interfaces.

2.0 CIRI PROTOCOL DESCRIPTION

Table 2-1 – Common IPS Radio Interface Applicability

Airborne Radio			Airborne IPS System	
			Radio-specific Adaptation	Common IPS Radio Interface
Legacy (non-IP) Radio	VDR	A750	Yes [1]	No [2]
IPS-enabled Radio	AeroMACS	A766	Yes [1]	Optional [3]
	LDACS	<i>Future</i>	<i>TBD [4]</i>	<i>TBD [4]</i>
	Certus	A771	Yes [1]	Optional [3]
	SB-Safety	A781	Yes [1]	Optional [3]
IP-enabled Radio	Gatelink WiFi	A763A / A822A	Out of scope of ARINC 858 [5]	
	Gatelink Cellular			
	Air-to-Ground Cellular	N/A		
	Ku / Ka SATCOM	A791 / A792		

Notes:

- For existing Airborne Radios that do not implement the CIRI protocol, the Airborne IPS System provides adaptation of radio-specific interfaces.
- Although the CIRI protocol is not intended for implementation in legacy (non-IP-based) radios such as a VDR, an implementer may elect to use the CIRI protocol for the interface between IPS functions and VDLm2 link layer functions that are internal to the system (e.g., Airborne IPS System) that implements these functions. This is an implementation-specific decision.
- The standards for IPS-enabled radios may be updated to specify the Common IPS Radio Interface Protocol in lieu of or in addition to existing radio-specific control plane and data plane interfaces.
- When a future LDACS standard is developed, the radio control plane and data plane interfaces with the Airborne IPS System may be specified as the Common IPS Radio Interface Protocol, in which case radio-specific adaptation would not be required.
- The Airborne IPS System is not expected to interface directly with IP-enabled radios in the Aircraft Information Services Domain (AISD) but rather with an intermediary device (e.g., an AISD router or an Aircraft Interface Device (AID)) that interfaces with the IP-enabled radios. As noted in ARINC 858 Part 1, Section 2, implementation of a cross-domain interface is aircraft architecture-dependent and out of scope of A858.

2.2 Functional Description

The CIRI protocol is designed for exchanging information between an Airborne IPS System and an IPS-enabled Airborne Radio via the on-aircraft communication means described in Section 2.3. The CIRI protocol supports the exchange of two message types: control-plane messages and data-plane messages.

The main functions provided by CIRI are summarized in the following bullets:

- Radio Status Signaling – Basic function that uses control-plane CIRI messages to provide the Airborne IPS System with up-to-date information about the status of datalink channels provided by onboard Airborne Radios. While this status information must include at least an indication of whether the datalink is operational (i.e., able to deliver data-plane packets to the ground), the protocol supports the exchange of additional detail (if available

2.0 CIRI PROTOCOL DESCRIPTION

from the Airborne Radio) that allows the Airborne IPS System to make more informed link decisions and ensure QoS of the communication.

- Data Packet Exchange – Optional function that uses data-plane CIRI messages to exchange air-to-ground and ground-to-air IPv6 packets between the Airborne IPS System and the Airborne Radio. The air-to-ground, and possibly the ground-to-air, packets may be associated with metadata, for example to differentiate among packets with different QoS needs or indicate whether the packet is subject to Required Communication Performance (RCP) requirements.
- Flow Control – Optional function that uses both control-plane and data-plane CIRI messages to enable throttling of the flow of air-to-ground packets contained in data-plane messages sent from the Airborne IPS System to the Airborne Radio. Flow control ensures that at any given time, only a bounded amount of data is queued for transmission in the Airborne Radio and the remaining data can be queued in the Airborne IPS System.

Note that the CIRI protocol does not provide any functions for controlling the Airborne Radios (e.g., enabling/disabling a radio, frequency tuning, mode/modulation selection, etc.). These radio control functions are provided by a radio-specific interface and protocol, which are out of the scope of this specification.

2.3 Interface Description

The CIRI protocol is designed to support a variety of on-board communication means, including Ethernet-based and ARINC 664-based aircraft networks, which are envisioned to be the future onboard network solutions when IPS is deployed.

As illustrated in [Figure 2-2](#), the CIRI protocol may use any on-aircraft communication means where the transport mechanism meets the requirements specified in Section 4.1.

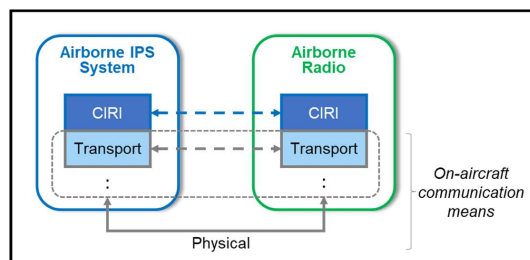

Figure 2-2 – Notional CIRI Protocol Context

[Figure 2-3](#) illustrates an example protocol stack, where the on-aircraft communication means uses User Datagram Protocol (UDP)/IPv4 over ethernet, which is representative of the onboard networks expected to be used when IPS is deployed.

2.0 CIRI PROTOCOL DESCRIPTION

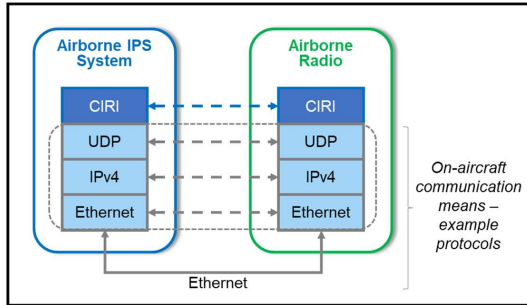

Figure 2-3 – Representative CIRI Protocol Context Example

2.4 Basic Communication Patterns

2.4.1 Control Plane

The primary purpose of the CIRI protocol is for an Airborne Radio to provide various status information to the Airborne IPS System. In the simplest variant, the Airborne Radio CIRI endpoint provides only discrete status for one or more datalink channels (see Section 4.2), but the CIRI protocol provides structures to convey additional information. All CIRI messages contain a Datalink Identifier option that uniquely identifies each individual Airborne Radio CIRI endpoint in the scope of the aircraft.

COMMENTARY

As noted previously in Section 02-2, the CIRI protocol does not provide the Airborne IPS System with the capabilities to control the Airborne Radios (e.g., enabling/disabling the radio, frequency tuning, etc.).

The basic control plane communication pattern is illustrated in Figure 2-4.

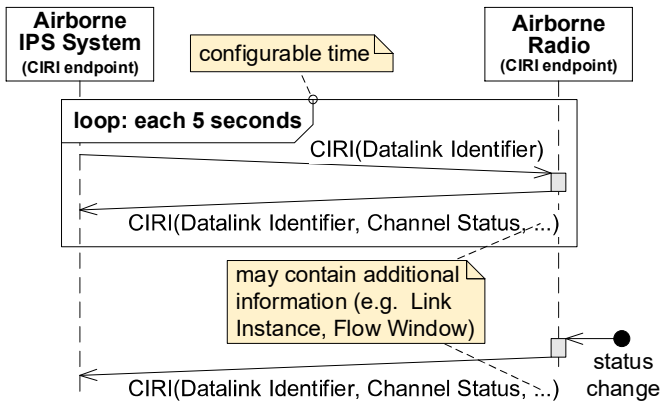

Figure 2-4 – Basic Control Plane Communication Pattern

The Airborne IPS System CIRI endpoint periodically sends a control-plane CIRI message to query the status of the Airborne Radio channels, and the Airborne

2.0 CIRI PROTOCOL DESCRIPTION

Radio CIRI endpoint replies with a control-plane CIRI message that includes Channel Status, and optionally other information. These messages also serve as a health monitoring of the Airborne Radio. Additionally, the Airborne Radio CIRI endpoint sends an unsolicited control-plane CIRI message whenever a datalink channel status changes. See Section 4.0 for details.

This protocol does not provide any means for the Airborne IPS System to dynamically “request” or to “subscribe to” any particular information from the Airborne Radio. It is assumed that the Airborne Radio is statically configured with regard to what kind of information is provided to the Airborne IPS System.

It is expected that different Airborne Radios are capable of providing different types of information. The Airborne IPS System should be designed to handle different types of information, for example, static configuration of what information is expected from which Airborne Radio. This document does not describe how this information is processed in the Airborne IPS System, as this is deemed to be a local implementation detail that does not impact interoperability.

2.4.2 Data Plane

Optionally, the CIRI protocol may also be used to carry the data-plane communication between Airborne IPS System and the Airborne Radio, in one or both directions. If enabled, the data-plane packets (i.e., IPv6 packets) are carried by data-plane CIRI messages in a Packet Data option. The basic data plane communication pattern is illustrated in [Figure 2-5](#).

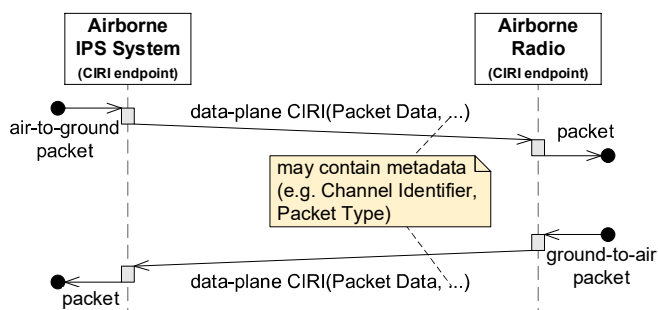

Figure 2-5 – Data Plane Communication Pattern

COMMENTARY

The CIRI protocol data plane communication is provided primarily to facilitate attaching metadata, such as Channel Identifier, to data packets, but it is not required for the control-plane CIRI operation. The Airborne Radio may gather all necessary information by other means; for example, a datalink providing two channels may use two independent plain data interfaces (e.g., two dedicated physical interfaces) to discriminate between packets of these channels.

2.5 Flow Control Mechanism Description

The CIRI protocol includes a flow control mechanism, which provides the ability to throttle the flow of packets from the Airborne IPS System to the Airborne Radio when data-plane CIRI messages are used to exchange data-plane communications.

2.0 CIRI PROTOCOL DESCRIPTION

A flow-controlled datalink channel is an Airborne Radio datalink channel to which the flow control mechanism is applied. The CIRI protocol can support flow control for zero or more datalink channels (see Section [Error! Reference source not found.4.2](#)).

A flow control example sequence, which uses a combination of control-plane and data-plane CIRI messages, is illustrated in [Figure 2-6](#).

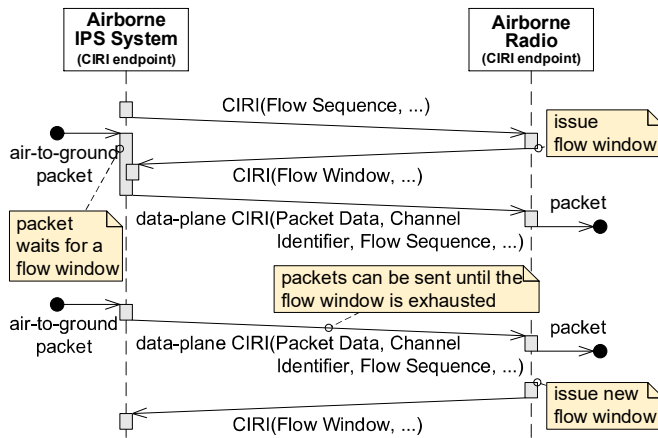

Figure 2-6 – Flow Control Example Sequence

For a flow-controlled datalink channel, the flow control mechanism can be summarized as follows:

- Using a control-plane CIRI message, the Airborne IPS System CIRI endpoint announces an arbitrary initial *Flow Sequence* value. The *Flow Sequence* is used as a counter of bytes sent within the flow-controlled datalink channel.
- Using a control-plane CIRI message, the Airborne Radio CIRI endpoint can then issue a *Flow Window*, specifying the number of bytes that can be accepted by the Airborne Radio in the datalink channel. The *Flow Window* is expressed as the highest *Flow Sequence* that can be sent by the Airborne IPS System CIRI endpoint. The Airborne Radio CIRI endpoint can compute the *Flow Window* as the most recently received *Flow Sequence* incremented by the number of bytes that can be accepted currently.
 - The Airborne Radio CIRI endpoint should issue a new *Flow Window* whenever appropriate (e.g., when the previous *Flow Window* was partially consumed, and radio resources are available again)
 - *Flow Sequence* and the *Flow Window* counters use a serial number arithmetic as defined in RFC 1982. This solves “wrap-around” issues.
 - Note that expressing the flow window in terms of *Flow Sequence* prevents some race conditions.
 - If the Airborne Radio CIRI endpoint does not implement flow control for the channel, then control-plane CIRI messages sent by the Airborne Radio CIRI endpoint do not contain the Flow Window option. This indicates that flow control should be disabled for the channel.

2.0 CIRI PROTOCOL DESCRIPTION

- For each data-plane CIRI message containing an air-to-ground packet within the flow-controlled datalink channel, the Airborne IPS System CIRI endpoint increments the *Flow Sequence* by the size of the packet (in bytes), effectively consuming part of the issued *Flow Window*. If the *Flow Sequence* cannot be incremented without exceeding the *Flow Window* (or if there is no *Flow Window* issued yet), then the air-to-ground packet is kept in a queue until the *Flow Window* is extended, until the packet expires, or until the packet is processed in another way (e.g., discarded when it became too old).

The goal of the flow control mechanism is to keep the Airborne Radio-internal queues at or below a policy-defined level, especially in the (expected) situation where the link between Airborne IPS System and the Airborne Radio has much higher throughput than the air-ground link. This enables prioritization (non-absolute) within the Airborne IPS System and helps to reduce the amount of lost data during a failover. Generally, the amount of data waiting in the Airborne Radio must be above a radio-specific threshold to achieve optimal performance. For example, a Satcom radio requests resources (e.g., timeslots) from the access network based on the amount of queued data. If flow control kept Satcom queues too low, the Satcom radio would request less than the maximum number of timeslots from the access network despite additional Satcom data queued in the Airborne IPS System; consequently, this would degrade the overall system performance.

2.6 Airborne Radio Reference Model

This section presents a notional, non-normative Airborne Radio architecture, together with a possible mapping of the architecture elements to CIRI functions.

As shown in [Figure 2-7](#), the Airborne Radio implements [multiple](#) transmit queues (e.g., to enable prioritization and different handling for data with different QoS). These transmit queues are described in CIRI as datalink channels. If the underlying L2/L1 layers do not distinguish between data from different transmit queues, then the Airborne Radio can report the same channel *Status* for all provided datalink channels. Alternatively, if each transmit queue is associated with a negotiated air-ground session (e.g., Packet Data Protocol [PDP] contexts used in Satcom), then the reported *Status* for each datalink channel should reflect the status of the corresponding session.

2.0 CIRI PROTOCOL DESCRIPTION

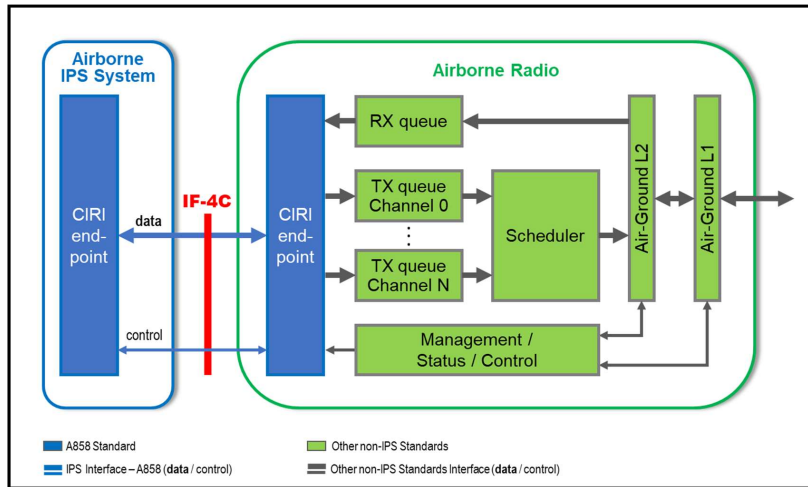

Figure 2-7 – Notional Airborne Radio Architecture

If the CIRI data plane functionality is used, then the air-to-ground packets received from the Airborne IPS System CIRI endpoint are marked with a *Channel ID*, which identifies a transmit queue that is used for the given packet.

If the CIRI flow control mechanism is used, then the space available in a transmit queue might be reflected directly in the flow window issued for the corresponding datalink channel. When the queue becomes full, then the corresponding flow window is (implicitly) exhausted and the Airborne IPS System CIRI endpoint stops sending additional packets to that channel. When some packets from the queue are processed, either by being delivered to the ground or discarded, then the Airborne Radio CIRI endpoint extends the flow window to account for the newly available queue space.

3.0 CIRI PROTOCOL MESSAGE STRUCTURE

3.0 CIRI PROTOCOL MESSAGE STRUCTURE

3.1 Message Format

Each CIRI message consists of a CIRI header and a sequence of CIRI options. All integers are encoded in network byte order (i.e., big endian).

A CIRI message is a “data-plane CIRI message” when the *Data Plane* flag is set to 1; otherwise, it is a “control-plane CIRI message.”

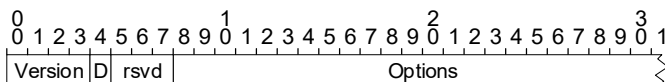

Figure 3-1 – CIRI Message Format

Table 3-1 – CIRI Message Fields

Field	Description	Value
<i>Version</i>	4-bit identifier	0x0: Invalid 0x1: Current version 0x2 to 0xF: Reserved for future use
<i>Data Plane (“D”)</i>	1-bit flag Identifies whether the message is a control-plane message or a data-plane message	0: Control-plane CIRI message. Packet Data option must not be present. 1: Data-plane CIRI message. Exactly one Packet Data option must be present (see Section 2.4.2).
<i>rsvd</i>	3-bit unused field Initialized to zero by the sender and must be ignored by the receiver	b000
<i>Options</i>	Variable-length field spanning to the end of this CIRI message. It consists of a sequence of one or more CIRI options. The order of options is not significant.	

3.2 Option Format

The following figure illustrates the CIRI option format.

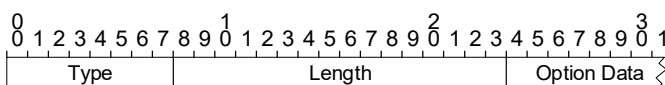

Figure 3-2 – CIRI Option Format

Table 3-2 – CIRI Option Fields

Field	Description	Value
<i>Type</i>	8-bit unsigned integer Identifies a specific CIRI option	Refer to Table 3-3
<i>Length</i>	16-bit unsigned integer Denotes the length in bytes of the <i>Option Data</i> field (not including <i>Type</i> and <i>Length</i>).	0 to $2^{16} - 1$
<i>Option Data</i>	Variable length field dependent on the specific option	

3.0 CIRI PROTOCOL MESSAGE STRUCTURE

If an option is received with an unrecognized *Type*, with undefined semantics in a given context (e.g., Expiration Time option in a control-plane CIRI message), or with a *Length* value that is less than expected, then the option must be ignored silently, and the remainder of the CIRI message must be processed as if the option was not present.

If an option is received with a *Length* greater than expected, then the recognized beginning of the option must be processed up to the expected length, and the surplus bytes must be ignored.

Table 3-3 summarizes the options defined for the CIRI protocol. The table also indicates in which situations the presence of the protocol option is mandatory (M), optional (O), or conditional (C), based on specific use cases, Notes are indicated by square brackets. Options that can be included multiple times in a CIRI message are marked as “multiple.”

COMMENTARY

CIRI Options that are not specified at the time of this writing are marked as reserved. To check for CIRI Options defined after publication of this document, consult the IPS Subcommittee page at: <https://aviation-ia.sae-itc.com/subcommittees/internet-protocol-suite>.

Table 3-3 – Common IPS Radio Interface Option Applicability

Option Type	Option Name	Defined in	Control Plane		Data Plane [1]	
			Airborne Radio to IPS System	IPS System to Airborne Radio	Airborne Radio to IPS System	IPS System to Airborne Radio
0	Reserved					
1	Datalink Identifier	§ 3.3.1	M	M	M	M
2	Reserved					
3	Link Instance	§ 3.3.2	O			
4	Reserved					
5	Channel Status	§ 3.3.3	M, multiple			
6	Flow Window	§ 3.3.5	C, multiple [2]			
7	ICAO Address	§ 3.3.10		M		
8 – 63	Reserved for future extensions					
64	SDU Status	ARINC 781	C [3]			
65 – 127	Reserved for future extensions					
128	Packet Data	§ 3.3.6			M	M
129	Channel Identifier	§ 3.3.7			O	O
130	Expiration Time	§ 3.3.8				O
131	Packet Type	§ 3.3.9			O	O
132 – 133	Reserved for future extensions					
134	Flow Sequence	§ 3.3.4		C, multiple [2]		C [2]
135 – 252	Reserved for future extensions					
253	Reserved for experimental use					
254	Reserved for experimental use					
255	Reserved					

3.0 CIRI PROTOCOL MESSAGE STRUCTURE

Option Type	Option Name	Defined in	Control Plane		Data Plane [1]	
			Airborne Radio to IPS System	IPS System to Airborne Radio	Airborne Radio to IPS System	IPS System to Airborne Radio
Notes:						
1. Applicable only when the CIRI protocol is used to exchange data-plane messages between the Airborne IPS System and an Airborne Radio.						
2. When the flow control functionality is used, the option is mandatory per the use cases described in the identified section in this document.						
2-3. Applicable only to ARINC 781 Satellite Data Units (SDUs).						

3.3 Message Option Specification

3.3.1 Datalink Identifier Option

This option identifies a datalink (and the associated Airborne Radio CIRI endpoint) in the scope of the aircraft. It must be present once in every CIRI message. Any CIRI message without the Datalink Identifier option, or with an unexpected ID value should be ignored.

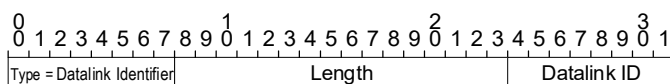

Figure 3-3 – Datalink Identifier Option

Table 3-4 – Datalink Identifier Option Fields

Field	Description	Value
Type	Datalink Identifier	1
Length	Option length	1
Datalink ID	8-bit unsigned integer Represents a configured datalink identifier	0 to 255

The *Datalink ID* value uniquely identifies an Airborne Radio CIRI endpoint. Values for individual Airborne Radios shall be set in accordance with the following table.

COMMENTARY

Datalink ID values that are not specified at the time of this writing are marked as reserved. To check for *Datalink ID* values defined after publication of this document, consult the IPS Subcommittee page at: <https://aviation-fa.sae-itc.com/subcommittees/internet-protocol-suite>.

Table 3-5 – Datalink ID Values

Airborne Radio	Value
VDLm2	0
SATCOM#1	1
SATCOM#2	2
LDACS	3
AeroMACS	4
Reserved for future use	5 to 127
Reserved for experimental use	128 to 255

3.0 CIRI PROTOCOL MESSAGE STRUCTURE

3.3.2 Link Instance Option

This option allows the Airborne Radio to announce the current *Link Instance ID*. The *Link Instance ID* uniquely identifies an access network, which implicitly identifies the combination of a particular datalink technology and a particular access network service provider, e.g., L-band safety Satcom provided by Inmarsat or LDACS provided by SITA. The values of *Link instance ID* for various datalink technologies and access network service providers are defined in ICAO Doc. 9896 Part I. The Airborne IPS System may use this value directly in the Air-Ground Mobility Interface (AGMI) protocol when it is required for global mobility (reference ICAO Doc. 9896).

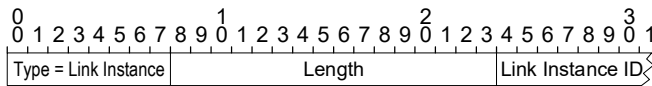

Figure 3-4 – Link Instance Option

Table 3-6 – Link Instance Option Fields

Field	Description	Value
<i>Type</i>	Link Instance	3
<i>Length</i>	Option length	1 to 8
<i>Link Instance ID</i>	Variable length unsigned integer. Represents a combination of the datalink technology and a particular access network, which therefore includes identification of an Air-Ground Communication Service Provider (ACSP).	0 to $2^{(8 \times Length)} - 1$

COMMENTARY

The Airborne IPS System may use the *Link Instance ID* as an input to the Multilink Decision Engine (MDE) function (reference ARINC 858 Part I). Note that the *Link Instance ID* applies to all channels provided by the datalink.

3.3.3 Channel Status Option

This option specifies the current status of one datalink channel (see Section [Error! Reference source not found.4.2](#)) managed by the Airborne Radio CIRI endpoint.

Every Airborne Radio CIRI endpoint must report status for *Channel ID* = 0 (“primary channel”), and it may report statuses for other channels. A CIRI message must not contain multiple Channel Status options with the same *Channel ID*.

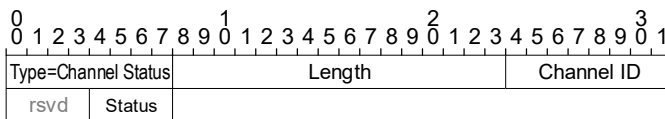

Figure 3-5 – Channel Status Option

Table 3-7 – Channel Status Option Fields

3.0 CIRI PROTOCOL MESSAGE STRUCTURE

Field	Description	Value
<i>Type</i>	Channel Status	5
<i>Length</i>	Option length	2
<i>Channel ID</i>	8-bit unsigned integer Identifies a datalink channel as defined in Section Error! Reference source not found,4.2	0 to 254: Datalink channel identifier 255: Reserved for future use
<i>rsvd</i>	4-bit unused field This field must be initialized to zero by the sender and must be ignored by the receiver	0x0
<i>Status</i>	4-bit unsigned integer Indicates the status of the datalink channel	0: Datalink channel is not operational ("link_down") 1 to 6: Datalink channel is operational. The meaning of individual operational values is datalink-specific, e.g., to indicate sub-nominal performance [1]. 7: Datalink channel is operational with nominal performance ("link_up") 8 to 15: Reserved for future extensions. Unless configured otherwise, the receiver should treat these values as meaning non-operational.
Notes:		
<ol style="list-style-type: none"> The following values are recommended for sub-nominal channel status: <ul style="list-style-type: none"> 1: Degraded datalink channel with an unknown performance and unknown impact on the user traffic ("best_effort") 4: Degraded datalink channel with a known performance degradation and known impact on user traffic ("link_degraded") 		

COMMENTARY

The status values 0 to 7 are chosen to correspond to the 3-bit *Status* field from the Datalink option in the AGMI protocol, as specified in ICAO Doc. 9896.

3.3.4 Flow Sequence Option

This option is used for the purpose of flow control (see Section 4.5). It signals the current *Flow Sequence* number for the given flow-controlled datalink channel. The *Flow Sequence* number is a counter of bytes of air-to-ground packets sent within the datalink channel used by the Airborne IPS System CIRI endpoint. It is included in both control-plane and data-plane CIRI messages.

The Flow Sequence option is included in all data-plane CIRI messages that are sent by the Airborne IPS System CIRI endpoint and which carry a data-plane packet that belongs to a flow-controlled datalink channel. The Flow Sequence option included in a data-plane CIRI message indicates value of the *Flow Sequence* counter after including the size of the data-plane packet in this CIRI message.

Note that the *Flow Sequence* counter uses a serial number arithmetic (modulo 2^{32}) as defined in RFC 1982.

3.0 CIRI PROTOCOL MESSAGE STRUCTURE

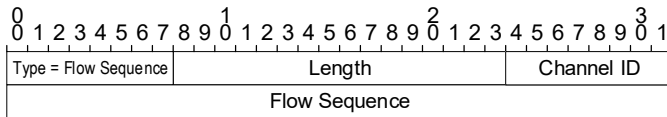

Figure 3-6 – Flow Sequence Option

Table 3-8 – Flow Sequence Option Fields

Field	Description	Value
Type	Flow Sequence	134
Length	Option length	5
Channel ID	8-bit unsigned integer Identifies a flow-controlled datalink channel	0 to 254: Datalink channel identifier 255: Reserved for future use.
Flow Sequence	32-bit unsigned integer Indicates the current Flow Sequence used by the Airborne IPS System CIRI endpoint	0 to $2^{32} - 1$

3.3.5 Flow Window Option

This option is used for the purpose of flow control (see Section 4.5). In each control-plane CIRI message sent by the Airborne Radio CIRI endpoint, there is one Flow Window option for each flow-controlled datalink channel. The Flow Window option may contain the *Flow Window* field.

A Flow Window option without the *Flow Window* field signals a request for Flow Sequence and invalidates any flow window issued previously for the datalink channel (see Section 4.5.1).

If the *Flow Window* field is present in a Flow Window option, then the value of the field indicates the highest *Flow Sequence* number that can be transmitted by the Airborne IPS System CIRI endpoint in the given datalink channel.

The *Flow Window* uses serial number arithmetic (modulo 2^{32}), as defined in RFC 1982. The Airborne Radio CIRI endpoint should use the smallest possible *Flow Window* that does not impair datalink performance.

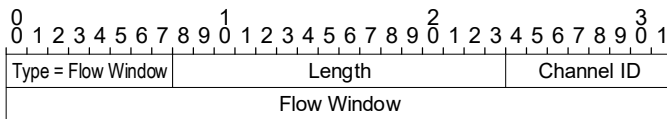

Figure 3-7 – Flow Window Option

Table 3-9 – Flow Window Option Fields

Field	Description	Value
Type	Flow Window	6
Length	Option length	1 (if the <i>Flow Window</i> field is not included) or 5 (if the <i>Flow Window</i> field is included)
Channel ID	8-bit unsigned integer	0 to 254: Datalink channel identifier 255: Reserved for future use.

3.0 CIRI PROTOCOL MESSAGE STRUCTURE

Field	Description	Value
	Identifies a flow-controlled datalink channel	
<i>Flow Window</i>	Optional 32-bit unsigned integer Indicates the highest flow sequence number that can be accepted by the Airborne Radio CIRI endpoint.	0 to $2^{32} - 1$

3.3.6 Packet Data Option

This option must be present in any data-plane CIRI message, and it must be the last option encoded in the data-plane CIRI message.

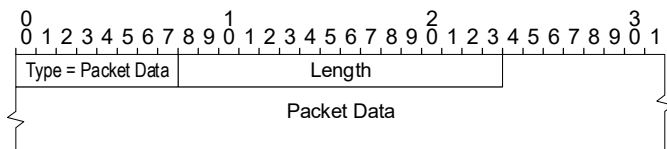

Figure 3-8 – Packet Data Option

Table 3-10 – Packet Data Option Fields

Field	Description	Value
<i>Type</i>	Packet Data	128
<i>Length</i>	Option length	0: No packet data 1 to $2^{16} - 1$: length of packet data
<i>Packet Data</i>	Variable-length sequence of bytes containing the data-plane packet bytes	

3.3.7 Channel Identifier Option

This option may be present in any data-plane CIRI message. It indicates that the accompanied packet belongs to the identified datalink channel (see Section [Error! Reference source not found.4.2](#)).

For air-to-ground packets, the Airborne Radio is requested to use the identified datalink channel to deliver the packet. The chosen channel may be reflected by flow control (see Section 4.5) and treatment within the Airborne Radio (e.g., prioritization).

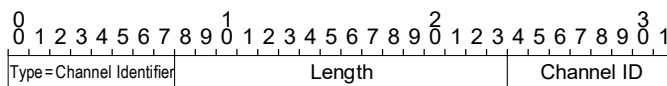

Figure 3-9 – Channel Identifier Option

Table 3-11 – Channel Identifier Option Fields

Field	Description	Value
<i>Type</i>	Channel Identifier	129
<i>Length</i>	Option length	1
<i>Channel ID</i>	8-bit unsigned integer	0 to 254: Datalink channel identifier 255: Reserved for future use.

3.0 CIRI PROTOCOL MESSAGE STRUCTURE

Field	Description	Value
	Identifies a channel as defined in Section Error! Reference source not found.4.2.	

3.3.8 Expiration Time Option

This option may be present in a data-plane CIRI message sent from the Airborne IPS System CIRI endpoint to the Airborne Radio CIRI endpoint. It indicates that after the expiration time, the conveyed [packet](#) is expired and may be discarded by the Airborne Radio CIRI endpoint.

If the Airborne Radio is capable of tracking the expiration time for individual packets, it should discard any packet not delivered within the expiration time, to preserve bandwidth for other traffic.

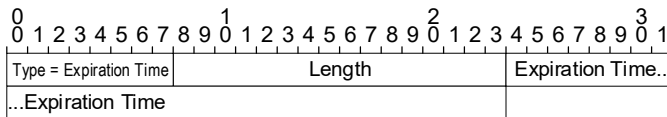

Figure 3-10 – Expiration Time Option

Table 3-12 – Expiration Time Option Fields

Field	Description	Value
Type	Expiration Time	130
Length	Option length	4
Expiration Time	32-bit unsigned integer. Indicates expiration time.	0: reserved for future use. The sender must not set <i>Expiration Time</i> to 0. The receiver must ignore an <i>Expiration Time</i> option with <i>Expiration Time</i> set to 0. 1 to 2 ³² - 1: expiration time in milliseconds

3.3.9 Packet Type Option

This option may be present in a data-plane CIRI message. It indicates the accompanied data-plane packet type (i.e., the type of data that is carried in the Packet Data option).

If this option is not present in a data-plane CIRI message, then the CIRI endpoint should use a default value suitable for the [associated channel of the](#) datalink. If a CIRI endpoint receives a Packet Type option with an unrecognized or unsupported *Packet Type* value, it should discard the accompanied packet.

Commented [JZ1]: Note: different channels of one datalink might assume different packet types by default. Expected usage: a channel dedicated to ACARS, other channels bearing IPS (i.e., packet type IPv6 or ROHC)

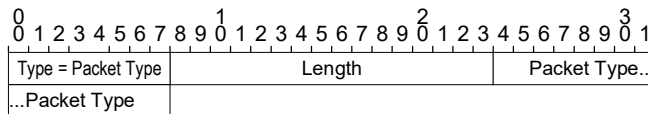

Figure 3-11 – Packet Type Option

Table 3-13 – Packet Type Option Fields

Field	Description	Value
Type	Packet Type	131

3.0 CIRI PROTOCOL MESSAGE STRUCTURE

Field	Description	Value
<i>Length</i>	Option length	2
<i>Packet Type</i>	16-bit unsigned integer. Identifies the data-plane packet type.	0x0000 to 0x00FF – Reserved for experimentation and local use 0x0100 – ARINC 618 (Note 1) 0x0101 to 0x05FF – Reserved for future use 0x0600 to 0xFFFF – Protocol identified by the IEEE Ethertype value. Reference: https://standards-oui.ieee.org/ethertype/eth.txt
<u>Notes:</u>		
1. This packet type is intended to carry ACARS ARINC 618 blocks. For other ACARS formats that may be dependent on architectural use cases, additional packet types will need to be defined.		

For example, a CIRI data-plane message carrying an IPv6 packet should use *Packet Type* = 0x86DD, and a data-plane message carrying and ROHC packet should use *Packet Type* = 0x22F1.

3.3.10 ICAO Address Option

[This option communicates the ICAO 24-bit address of the aircraft from the Airborne IPS System to the Airborne Radio. It must be present once in every CIRI control-plane message sent from the Airborne IPS System to the Airborne Radio. Any CIRI message without the ICAO Address Option, or with an unexpected ICAO Address value may be ignored by the Airborne Radio.](#)

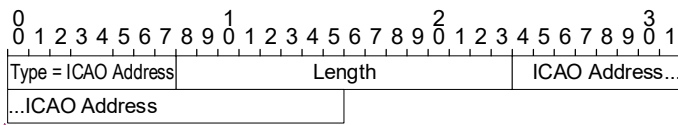

Figure 3-12 – ICAO Address Option

Table 3-14 – ICAO Address Option Fields

Field	Description	Value
<i>Type</i>	ICAO Address	7
<i>Length</i>	Option length	3
<i>ICAO Address</i>	24-bit unsigned integer. The ICAO 24-bit Aircraft Address (MSB-first)	ICAO 24-bit Aircraft Address

Field Code Changed

4.0 CIRI PROTOCOL OPERATION

4.0 CIRI PROTOCOL OPERATION

The CIRI protocol operates between a pair of endpoints. Each pair consists of one Airborne IPS System CIRI endpoint and one Airborne Radio CIRI endpoint. Both endpoints must be configured with a *Datalink ID*, uniquely identifying the pair within the aircraft. Every CIRI message exchanged between those endpoints must contain a Datalink Identifier option with this *Datalink ID* value.

4.1 Transport Requirements

4.1.1 General

CIRI protocol operation relies on a datagram-oriented transport mechanism between the Airborne IPS System CIRI endpoint and Airborne Radio CIRI endpoint. A single transport channel may be shared by multiple logical CIRI endpoints. In that case, they are distinguished by *Datalink ID*.

The transport protocol must support a payload size that is sufficient to accommodate the largest CIRI message in a particular deployment. As a minimum, the transport protocol should support a payload size of 1312 bytes, which accommodates a data-plane CIRI message containing IPv6 packets no larger than 1280 bytes plus all currently defined CIRI options. Per the IPS Profiles in RTCA DO-379A and EUROCAE ED-262A, IPv6 packets larger than 1280 bytes do not have to be supported.

COMMENTARY

Control-plane CIRI messages are expected to be much smaller than data-plane CIRI messages. A 1312-byte control-plane CIRI message can contain all mandatory and optional information sent from an Airborne Radio CIRI endpoint to the Airborne IPS System CIRI endpoint, including Channel Status and Flow Windows for up to 99 flow-controlled datalink channels (which vastly exceeds the expected amount of deployed datalink channels).

Because the communication may be initiated by both peers, it is recommended that addressing is, if needed by the transport protocol, statically configured on both CIRI endpoints.

The following section provides specific recommendations for implementations using UDP; these recommendations can be applied to any transport protocol mechanism in which each message is sent with a “source” identifier and a “destination” identifier.

4.1.2 Considerations for UDP-based Transport

For implementations that exchange CIRI messages over UDP as shown in the example in [Figure 2-3](#), each CIRI endpoint is configured with a local IP address and a UDP port number for the CIRI control plane and for each supported datalink channel of the CIRI data plane. Different CIRI endpoint implementations may impose different restrictions on whether the local IP addresses and UDP ports are the same or different for the CIRI control plane and for each datalink channel of CIRI data plane.

Each CIRI endpoint is also configured with a remote peer IP address and a UDP port number for the CIRI control plane and for each supported datalink channel of CIRI data plane. This must match the configuration of the remote peer CIRI

4.0 CIRI PROTOCOL OPERATION

endpoint. A CIRI message is sent from the local IP address and UDP port number (i.e., source) to the remote peer IP address and UDP port number (i.e., destination) according to the CIRI message details.

COMMENTARY

As an example, one CIRI endpoint implementation may use only one local UDP port number and one IP address for all CIRI messages, while another CIRI implementation may require using different local port numbers for data-plane CIRI messages for each datalink channel. To accommodate this diversity, a CIRI endpoint implementation should support configuring separate remote peer IP addresses and port numbers for control-plane messages and for each datalink channel of the CIRI data plane.

4.2 Channels

A datalink channel is a “transport service” for sending air-to-ground packets; this is different than the radio RF channel. Each air-to-ground packet given to the Airborne Radio must be associated with one datalink channel. If the Airborne Radio gets the packet from a data-plane CIRI message, then the channel is identified by the Channel Identifier option (see Section 4.4.3). Other data plane interfaces and protocols may define other means to specify a channel for the air-to-ground traffic.

A datalink channel is identified by *Channel ID*, which is an integer between 0 and 254:

- *Channel ID* 0 identifies the primary channel; all Airborne Radios must provide this channel.
- *Channel ID* 1 to 254 identify additional channels, if provided by the Airborne Radio. [The](#) semantics of these channels are deployment specific.
- *Channel ID* 255 is reserved. A CIRI endpoint receiver must ignore any option that contains *Channel ID* 255 and process the CIRI message as if the option is not present.

The CIRI protocol includes the *Channel ID* in the Channel Status option, Channel Identifier option, Flow Sequence option, and Flow Window option.

For each of the supported channels, the Airborne Radio CIRI endpoint reports the channel status and accepts air-to-ground packets associated with each channel. The meaning of the individual *Channel IDs* is radio-specific. It is assumed that the set of channels provided by an Airborne Radio does not change over time, and that the Airborne IPS System CIRI endpoint is configured with regard to how individual *Channel IDs* supported by an Airborne Radio are used.

COMMENTARY

As an example, an Airborne Radio may provide a “high-priority” channel for RCP/ Required Surveillance Performance (RSP)-bound traffic (e.g., ATS applications), and a second “lower priority” channel for traffic without RCP/RSP constraints (e.g., most AOC applications).

It is recommended that mobility and multilink signaling messages (e.g., AGMI messages) should be sent over the primary channel (*Channel ID* = 0).

4.0 CIRI PROTOCOL OPERATION

4.3 Airborne IPS System CIRI Endpoint Operation

4.3.1 Configuration

The following must be configured in the Airborne IPS System CIRI endpoint for each peer Airborne Radio CIRI endpoint, [which must support the protocol performance requirements specified in Section 4.4.2.2](#):

- Transport Mechanism Parameters – configuration of the on-aircraft communication means for message exchanges between CIRI protocol peers (see Section 4.1).
- *Datalink ID* – an 8-bit unsigned integer matching the *Datalink ID* of the peer Airborne Radio CIRI endpoint.
- ResponseInterval – a time interval that an Airborne IPS System CIRI endpoint waits for a response to any control-plane CIRI message sent to an Airborne Radio CIRI endpoint.
 - Default value: [3000ms1500ms](#)
- HelloInterval – a maximal time between two consecutive control-plane CIRI messages sent by Airborne IPS System CIRI endpoint.
 - Default value: 5000ms
- MaxUnanswered – if the number of CIRI protocol messages unanswered by the Airborne Radio CIRI endpoint exceeds this number, then the Airborne Radio is considered non-operational, and the datalink channel status for all applicable channels is set to a non-operational status “unknown.”
 - Default value: 2
- Datalink Channels – When the CIRI protocol is used to exchange data-plane messages, then the Airborne IPS System CIRI endpoint may be configured to send different air-to-ground packets via different channels. [The configuration](#) of the function that assigns a *Channel ID* to each air-to-ground packet is an implementation detail of the Airborne IPS System that is not specified in this document.
 - If the Airborne IPS System CIRI endpoint implements flow control, then each datalink channel may be optionally configured to be flow-controlled.

COMMENTARY

For example, an Airborne IPS System implementation can distinguish between “High priority” and “Low priority” air-to-ground traffic. For each of these traffic types, this implementation can be configured with:

- A *Channel ID* that is associated with the traffic type.
- A Boolean flag that specifies whether flow control is used for this traffic type.

To determine the current capability of the Airborne Radio to forward air-to-ground packets of a given *Channel ID*, the Airborne IPS System CIRI endpoint can use the channel *Status* reported by the Airborne Radio CIRI endpoint. When an air-to-ground packet of a given traffic type is sent to the Airborne Radio CIRI endpoint, the Airborne IPS System CIRI endpoint includes the Channel Identifier option with the configured *Channel ID*.

Commented [MO2]: Post-M27 (Radek Z.) - Specify ranges (min/max/default) for:
 - ResponseInterval
 - HelloInterval
 - MaxUnanswered

Commented [MO3R2]: 13-Feb: Agree to add. Honeywell to propose values.

4.0 CIRI PROTOCOL OPERATION

Note that the logic used in the Airborne IPS System may be more complex. The decision of what channel to use for what air-to-ground packet may be based on the currently reported Channel Status and other available parameters.

An Airborne IPS System CIRI endpoint implementation is not required to support all CIRI protocol features. It may need other configuration information not specified in this document, for example:

- Inclusion of other metadata in data-plane messages (e.g., Expiration Time option)
- Processing of status information received from the Airborne Radio (see Section 4.3.3).
- Handling of packets waiting in the “outbox” queues (for example expiration policy and prioritization configuration).

4.3.2 Control Plane Operation

An Airborne IPS System CIRI endpoint sends a control-plane CIRI message containing configured Datalink Identifier option to an Airborne Radio CIRI endpoint immediately after initialization and then periodically (per the HelloInterval period).

If the Airborne IPS System CIRI endpoint does not receive a response within ResponseInterval for a control-plane CIRI message, then another control-plane CIRI message is sent. If the Airborne IPS System CIRI endpoint does not receive a response for more than MaxUnanswered control-plane CIRI messages in a row, then the datalink is considered to be non-responsive and status is set to a non-operational status “unknown” for all channels provided by the datalink.

COMMENTARY

When an Airborne Radio is considered to be non-operational as described above, then the Airborne IPS System CIRI endpoint sends a control-plane CIRI message to the Airborne Radio CIRI endpoint every ResponseInterval seconds until it receives a control-plane CIRI message response.

Upon receiving a control-plane CIRI message with a valid Datalink Identifier option, the Airborne IPS System CIRI endpoint updates its status information according to Channel Status options included in that message and possibly from other inputs. It may also note information from other included options. This operation is summarized in [Figure 4-1](#). Only datalink channels reporting an operational status can be used to deliver data-plane packets to the ground. Section 4.3.2.1 contains further recommendations for processing of the information from the Airborne Radio CIRI endpoint.

4.0 CIRI PROTOCOL OPERATION

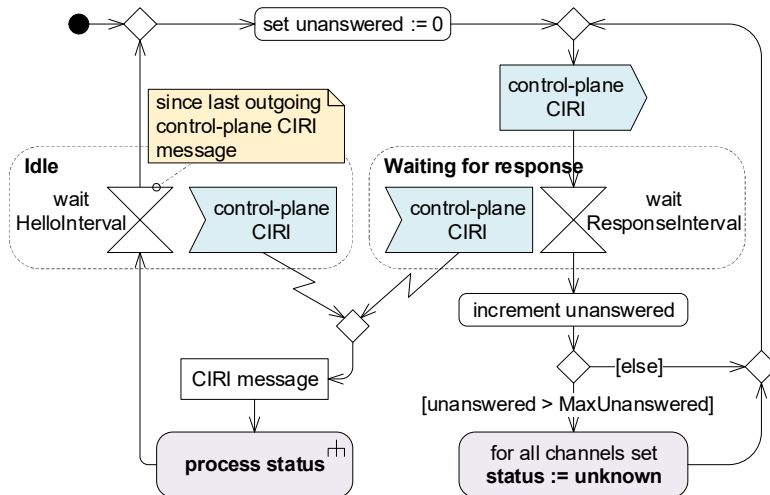

Figure 4-1 – Airborne IPS System CIRI Endpoint Control Plane Operation

If the Airborne IPS System CIRI endpoint is configured to use the Flow control mechanism, then Section 4.5.1 also applies.

COMMENTARY

To achieve optimal datalink performance, the Airborne IPS System CIRI endpoint should use the provided *Flow Window* as much as possible, i.e., keep the air-to-ground packet in its queues only if the packet cannot “fit” into the currently active *Flow Window*. On the other hand, a violation of the *Flow Window* by the Airborne IPS System CIRI endpoint may result in a packet loss, e.g., due to exceeding the capacity of the transmission queue in the Airborne Radio.

4.3.2.1 CIRI Control Plane Message

Every control-plane CIRI message sent by the Airborne IPS System CIRI endpoint has the *Data-plane* flag set to 0 in the CIRI header and contains:

- one Datalink Identifier option
- one ICAO Address option
- zero or more Flow Sequence options.

Note that for each flow-controlled datalink channel (see Section 4.5), there is zero or one corresponding Flow Sequence option.

4.3.3 Status Processing

The protocol specification does not require the Airborne IPS System to process the status information received from the Airborne Radio in any particular way, but the following bullets summarize a representative approach:

4.0 CIRI PROTOCOL OPERATION

- Channel Status options indicate the current status of datalink channels.
 - This is the primary indication of whether the datalink can be used to convey data-plane traffic to and from the ground.
 - The Airborne IPS System may use any other appropriate knowledge to supplement (or override) *Status* announced by the Airborne Radio CIRI endpoint.
 - If the AGMI is used for mobility and multilink signaling, then the *Status* of the primary channel (*Channel ID* = 0) might directly map to datalink status used in the AGMI protocol, as specified in ICAO Doc. 9896.
- Link Instance option may be used to identify a datalink's current communication service provider.
 - This information might be necessary for the mobility and multilink signaling protocol. In the case of AGMI, the value of *Link Instance ID* is intended to be directly used in AGMI Datalink option and preferences, as specified in ICAO Doc. 9896.

4.3.4 Data Plane Operation

Optionally, the CIRI protocol may be used to exchange data-plane traffic between an Airborne IPS System CIRI endpoint and an Airborne Radio CIRI endpoint.

When the Airborne IPS System CIRI endpoint receives a valid data-plane CIRI message from a peer Airborne Radio CIRI endpoint, then the packet contained in the data-plane CIRI message is processed either locally or forwarded to the appropriate destination in the aircraft.

When the Airborne IPS System CIRI endpoint wishes to send a packet for transmission via a particular datalink, then it sends a data-plane CIRI message with this packet to the peer Airborne Radio CIRI endpoint. This CIRI message may contain metadata describing the packet.

If the Airborne IPS System CIRI endpoint is configured to use the flow control mechanism, then Section 4.5.1 also applies.

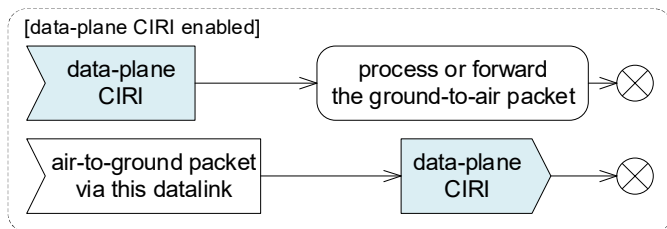

Figure 4-2 – Airborne IPS System CIRI Endpoint Data Plane Operation

4.3.4.1 CIRI Data Plane Message

Every data-plane CIRI message sent from Airborne IPS System CIRI endpoint has the *Data-plane* flag set to 1 in the CIRI header, and it contains exactly one Packet Data option and exactly one Datalink Identifier option. It may also contain:

- zero or one Channel Identifier option
- zero or one Expiration Time option

4.0 CIRI PROTOCOL OPERATION

- zero or one Flow Sequence option.
If the Flow Sequence option is present, then the CIRI message must also contain a Channel Identifier option with the same *Channel ID*
- zero or one Packet Type option.

These options describe properties of the packet carried by the Packet Data option, which must be the last option encoded in the CIRI message.

4.4 Airborne Radio CIRI Endpoint Operation

4.4.1 Configuration

The following must be configured in each Airborne Radio CIRI endpoint consistent with the configuration of the peer Airborne IPS System CIRI endpoint:

- Transport Mechanism Parameters – configuration of the on-aircraft communication means for message exchanges between CIRI protocol peers (see Section 4.1).
- Datalink ID – an 8-bit unsigned integer matching the *Datalink ID* of the peer Airborne IPS System CIRI endpoint.
- Datalink Channels – When the CIRI protocol is used to exchange data-plane messages, then the Airborne Radio CIRI endpoint is configured with one or more datalink channels. It must support at least the primary channel (*Channel ID* = 0), and it may be able to support a number of other channels (see Section [Error! Reference source not found.4-2](#)). Each supported channel includes:
 - *Channel ID*, which is used to identify the channel in CIRI messages containing the Channel Status option or Channel Identifier option.
 - Internal representation of the channel that specifies the status that is reported in the Channel Status option and that determines how air-to-ground packets belonging to this channel are managed when the CIRI protocol is used to exchange data-plane messages.
 - Optionally, the channel may be flow-controlled (see Section 4.5), in which case, the Airborne Radio CIRI endpoint is configured with an internal representation of the channel flow. The internal representation is responsible for managing the *Flow Window* (see Section 4.5.2).

The structure of configuration of the internal representations of datalink channels and flows is an implementation detail of the Airborne Radio that is not specified in this document.

COMMENTARY

An implementation does not have to support all CIRI features. For example, an Airborne Radio implementation might support only:

- The primary channel (*Channel ID* = 0) with no flow control
- Up to N flow-controlled datalink channels.

4.4.2 Control Plane Operation

The Airborne Radio CIRI endpoint reacts to events, as summarized in [Figure 4-3](#) [Figure 4-3](#). Whenever:

4.0 CIRI PROTOCOL OPERATION

- A valid control-plane CIRI message is received from the peer Airborne IPS System CIRI endpoint, or
- Datalink channel status changes, or
- Optionally, whenever new information is available, e.g., Flow Window update.

Then the Airborne Radio CIRI endpoint sends a control-plane CIRI message (see Section 4.4.2.1).

If the Airborne Radio CIRI endpoint is configured to use the flow control mechanism, then Section 4.5.2 also applies.

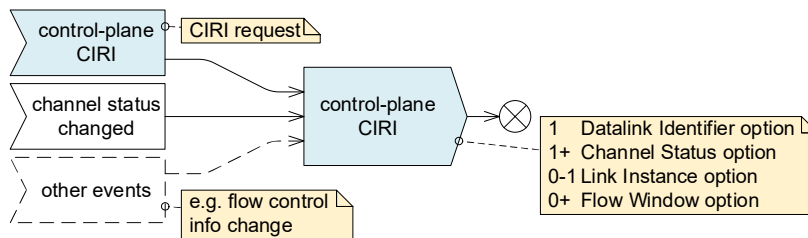

Figure 4-3 – Airborne Radio CIRI Endpoint Control Plane Operation

COMMENTARY

It is assumed that the datalink channel status tracking function implements hysteresis as necessary to prevent reporting changes of datalink status too frequently. On the other hand, this should be balanced with the need to provide information about datalink status in a timely manner. Details are deemed datalink and implementation specific.

4.4.2.1 CIRI Control Plane Message

The control-plane CIRI message sent by the Airborne Radio CIRI endpoint contains:

- one Datalink Identifier option
- one or more Channel Status options with the current status of all configured channels.
- zero or one Link Instance option
- zero or more Flow Window options (see Section 4.5.2)
 - For each flow-controlled datalink channel, there is one Flow Window option.

4.4.2.2 CIRI Control Plane Performance Requirements

The Airborne Radio CIRI endpoint shall be able to receive at least one CIRI Control Plane message every 100 milliseconds.

The Airborne Radio CIRI endpoint shall respond to a received CIRI Control Plane message within one second.

4.0 CIRI PROTOCOL OPERATION

4.4.3 Data Plane Operation

Optionally, the CIRI protocol may be used to exchange data-plane traffic between an Airborne Radio CIRI endpoint and an Airborne IPS System CIRI endpoint.

When an Airborne Radio CIRI endpoint receives a valid data-plane CIRI message from the peer Airborne IPS System CIRI endpoint, then the packet contained in the data-plane CIRI message is queued for transmission over the datalink channel specified in the Channel Identifier option. If the CIRI message does not contain the Channel Identifier option, then *Channel ID = 0* (the primary channel) is implied. If the CIRI message indicates an invalid *Channel ID* in a Channel Identifier option, then the Airborne Radio CIRI endpoint should discard the packet. If the CIRI message contains any other metadata (e.g., Expiration Time option), then this information should be associated with the packet.

Whenever the Airborne Radio receives a ground-to-air packet, the Airborne Radio CIRI endpoint sends a data-plane CIRI messages containing this packet to the peer Airborne IPS System CIRI endpoint (see Section 2.4.2).

If the Airborne Radio CIRI endpoint is configured to use the flow control mechanism, then Section 4.5.2 also applies.

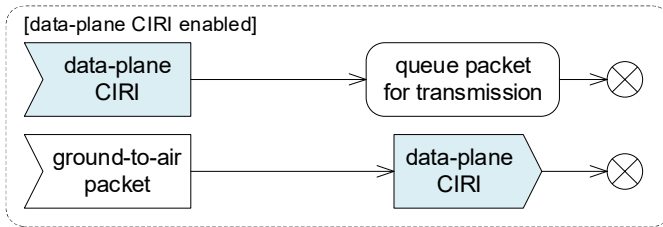

Figure 4-4 – Airborne Radio CIRI Endpoint Data Plane Operation

4.4.3.1 CIRI Data Plane Message

Every data-plane CIRI message sent by the Airborne Radio CIRI endpoint has the *Data-plane* flag set to 1 in the CIRI header and contains exactly one Datalink Identifier option and exactly one Packet Data option. It may also contain:

- zero or one Channel Identifier option
- zero or one Packet Type option.

The Packet Data option must be the last option encoded in the CIRI message.

4.5 Flow Control

The flow control mechanism is an optional feature of the CIRI protocol. When data-plane CIRI messages are employed, then the CIRI flow control mechanism provides a means for the Airborne Radio CIRI endpoint to govern the amount of data sent by the Airborne IPS System CIRI endpoint. The Airborne Radio CIRI endpoint may be configured to provide a flow control mechanism for zero or more flow-controlled datalink channels, where each datalink channel is flow-controlled independently.

COMMENTARY

An implementor of the Flow Control mechanism needs to ensure that the mechanism as such does not degrade the performance allocated

4.0 CIRI PROTOCOL OPERATION

to the aircraft. This can be achieved, for example, by applying the Flow Control mechanism only to non-safety-critical data to mitigate potential impact on safety critical data.

A **flow sequence** is a counter of the bytes of air-to-ground packets. It is assigned by the Airborne IPS System, and for each air-to-ground packet in the flow-controlled datalink channel, the counter is incremented by size of the packet. It is advertised in a Flow Sequence option.

A **flow window** is a license for some amount of air-to-ground data that the Airborne IPS System can safely pass to the Airborne Radio. The Flow Window is issued by the Airborne Radio CIRI endpoint, and it is expressed as the highest flow sequence number that can be transmitted by the Airborne IPS System CIRI endpoint in the given datalink channel based on previously received Flow Sequence option.

COMMENTARY

The main purpose of the flow control mechanism is to limit accumulation of packets in the Airborne Radio, and to instead queue these packets in the Airborne IPS System, without sacrificing the datalink performance. The Airborne Radio CIRI endpoint should issue the smallest possible Flow Window that does not impair datalink performance.

All mathematical operations (including comparison) on Flow Window and Flow Sequence follow sequence number arithmetic (modulo 2^{32}), as defined in RFC 1982. This is emphasized in the following text as “sn” subscript ($+_{sn}$, \leq_{sn}).

Flow control operation from the perspective of the Airborne IPS System and the Airborne Radio is described in detail in the following sections.

COMMENTARY

The presented flow control mechanism assumes use of the CIRI data-plane functionality. It might be possible to define a similar flow control mechanism that works with other data-plane protocols, but this option is not specified in this document.

4.5.1 Airborne IPS System Flow Control Operation

For all flow-controlled datalink channels (see Section 4.3.1), the Airborne IPS System CIRI endpoint keeps track of the current *Flow Sequence* and *Current Flow Window*. The *Flow Sequence* should be initialized to zero and the *Current Flow Window* is initialized to “invalid.”

Each control-plane CIRI message sent to the Airborne Radio CIRI endpoint must contain a Flow Sequence option for each datalink channel that is configured to be flow-controlled and that has an “invalid” *Current Flow Window*.

When the Airborne IPS System CIRI endpoint receives a control-plane CIRI message without the Flow Window option for any datalink channel that is configured to be flow-controlled, then flow control is disabled for this datalink channel. Data-plane packets belonging to the channel can then be sent to the Airborne Radio unthrottled, as if flow control was not configured for the channel (the packets may be dropped by the radio). When a Flow Window option is received for the channel, the flow control is re-enabled.

4.0 CIRI PROTOCOL OPERATION

When the Airborne IPS System CIRI endpoint receives a Flow Window option for a flow-controlled datalink channel without the *Flow Window* field (i.e., having *Length* = 1), then it must set the *Current Flow Window* for the channel to “invalid” and return a control-plane CIRI message that contains a Flow Sequence option for each flow-controlled datalink channel which has the *Current Flow Window* “invalid.”

COMMENTARY

A Flow Window option without the *Flow Window* field is used by the Airborne Radio CIRI endpoint to solicit the Flow Sequence from the Airborne IPS System CIRI endpoint. For example, this can be used after the Airborne Radio restarts.

When the Airborne IPS System CIRI endpoint receives a Flow Window option for a flow-controlled datalink channel that includes the *Flow Window* field (i.e., having *Length* ≥ 5), then the *Current Flow Window* for the given channel is updated to the received value. The *Current Flow Window* remains valid until another Flow Window option is received for that channel or until the channel becomes non-operational (e.g., by receiving *Status* = “link_down” in a Channel Status option).

When the Airborne IPS System CIRI endpoint wants to send an air-to-ground packet that belongs to a flow-controlled datalink channel, then it must not exceed the issued *Flow Window*:

If there is a valid *Current Flow Window* for that datalink channel, and if

$$\text{Flow Sequence} +_{sn} (\text{packet size in bytes}) \leq_{sn} \text{Current Flow Window},$$

then the *Flow Sequence* for this datalink channel is incremented by the packet size (in bytes) and the packet is sent to the Airborne Radio. The corresponding data-plane CIRI message must include a Flow Sequence option with the updated *Flow Sequence* as well as a Channel Identifier option.

COMMENTARY

Sending the updated *Flow Sequence* counter along with the data packet allows for tight synchronization of the *Current Flow Window* parameter between the Airborne IPS System CIRI endpoint and the Airborne Radio CIRI endpoint. The Airborne Radio CIRI endpoint is expected to send the *Flow Window* field and the most recently received sequence number.

If there is no valid *Current Flow Window*, or if the updated *Flow Sequence* would exceed the window, then the packet must not be sent to the Airborne Radio. The Airborne IPS System CIRI endpoint may send the packet to the Airborne Radio when the flow window is extended, or it may process the packet another way, e.g., discards the packet because it became too old.

Example operation of the data plane in the air-to-ground direction is summarized in [Figure 4-5](#).

4.0 CIRI PROTOCOL OPERATION

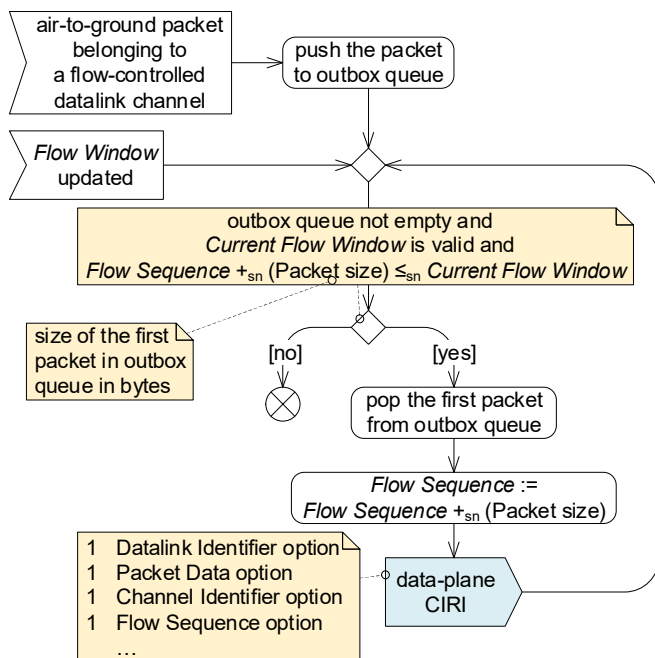

Figure 4-5 – Example Operation of the Airborne IPS System CIRI Endpoint Data Plane in the Air-Ground Direction with Flow Control

4.5.2 Airborne Radio Flow Control Operation

For each flow-controlled datalink channel (see Section 4.4.1), the Airborne Radio CIRI endpoint keeps track of the *Highest Flow Sequence* and the *Current Flow Window*. These variables are initialized to “invalid.” If these variables are not invalid, then the following invariant (INV) must hold:

$$\text{Highest Flow Sequence} \leq_{sn} \text{Current Flow Window} \quad (\text{INV})$$

For each flow-controlled datalink channel, all control-plane CIRI messages sent by the Airborne Radio CIRI endpoint contain one Flow Window option with the *Flow Window* field set to value of the *Current Flow Window* for that channel. If the *Current Flow Window* for that channel is invalid, then the *Flow Window* field is omitted (i.e., the Flow Window option has *Length* = 1).

After initialization, the Airborne Radio CIRI endpoint sends a control-plane CIRI message having a Flow Window option without the *Flow Window* field for each flow-controlled datalink channel.

When the Airborne Radio CIRI endpoint:

- receives a Flow Sequence option in a control-plane CIRI message, or
- receives a Flow Sequence option in a data-plane CIRI message and the *Current Flow Window* for the datalink channel is invalid,

4.0 CIRI PROTOCOL OPERATION

then the *Highest Flow Sequence* is set to the received *Flow Sequence* and the *Current Flow Window* variable is updated to a valid value, such that

$$\text{Highest Flow Sequence} +_{sn} (\text{size of the flow window}) = \text{Current Flow Window}.$$

The size of the flow window should use the lowest possible value that does not impair datalink service performance.

When the Airborne Radio CIRI endpoint receives a *Flow Sequence* option for a flow-controlled data-plane CIRI message and the *Current Flow Window* for the channel has a valid value, and if:

$$\text{Highest Flow Sequence} \leq_{sn} (\text{Flow Sequence in the CIRI message})$$

Then the *Highest Flow Sequence* is set to the received *Flow Sequence*. At this point, if the invariant (INV) does not hold, then the *Current Flow Window* is set to the *Highest Flow Sequence*.

When the Airborne Radio CIRI endpoint receives a *Flow Sequence* option for a flow-controlled channel in a data-plane CIRI message and the *Current Flow Window* for the channel has a valid value, and if:

$$\text{Highest Flow Sequence} \leq_{sn} (\text{Flow Sequence in the CIRI message})$$

Then the *Highest Flow Sequence* is set to the received *Flow Sequence*. At this point, if the invariant (INV) does not hold, then the *Current Flow Window* is set to the *Highest Flow Sequence*.

At any time, the Airborne Radio CIRI endpoint may decide to extend (or shrink) the issued *Flow Window* for a datalink channel, by changing the *Current Flow Window* variable for the channel. When it does, it must send an unsolicited control-plane CIRI message with the updated information.

The Airborne Radio CIRI endpoint should extend the flow window and send the corresponding unsolicited control-plane CIRI message whenever the Airborne Radio has resources available to manage additional air-to-ground traffic, e.g., because it has already transmitted some of the air-to-ground packets to the ground and released resources.

COMMENTARY

When the Airborne Radio CIRI endpoint decides to shrink the flow window, it must be prepared to handle out-of-sync data-plane CIRI messages that the Airborne IPS System CIRI endpoint transmitted according to the previously issued flow window.

4.5.3 Flow Control Example

Air-to-ground throughput of a Satcom datalink depends on “time slots” assigned by the access network infrastructure, and assignment of the time slots is driven by amount of data queued in the Satcom Airborne Radio. So, the Airborne Radio can try to keep its queues at a “watermark” level. This ensures, with some level of confidence, that the Satcom datalink uses available resources optimally if there are any air-to-ground data, but also that the data are not queued in the radio unnecessarily.

In the example above, the *Flow Window* indicated by the Airborne Radio CIRI endpoint can be computed as follows:

4.0 CIRI PROTOCOL OPERATION

Flow Window: = *Highest Flow Sequence* +_{sn} max(0, watermark₀ + (nominal_throughput × period) – queued_data_size)

where:

- *Highest Flow Sequence* is the highest *Flow Sequence* recently received from the Airborne IPS System CIRI endpoint for the given datalink channel
- watermark₀ is the amount of data that should be queued at any point of time to achieve optimal performance, e.g., to request all time slots available
- nominal_throughput is best-case throughput of the datalink
- period is time between two consecutive CIRI messages with the Flow Window options and
- queued_data_size is the amount of data already waiting for transmission in the Airborne Radio queues.

**ATTACHMENT 1
LIST OF ACRONYMS**

ATTACHMENT 1 LIST OF ACRONYMS

AAC	Aeronautical Administrative Communications
ACARS	Aircraft Communications Addressing and Reporting System
ACSP	Air-Ground Communication Service Provider
A-G or A/G	Air-to-Ground
AEEC	Airlines Electronic Engineering Committee
AeroMACS	Aeronautical Mobile Airport Communications System
AGMI	Air-Ground Mobility Interface
AID	Aircraft Interface Device
AISD	Aircraft Information Services Domain
AOC	Airline or Aeronautical Operational Control
ATC	Air Traffic Control
ATN	Aeronautical Telecommunication Network
ATS	Air Traffic Services
BLOS	Beyond Line Of Sight
CIRI	Common IPS Radio Interface
COTS	Commercial Off The Shelf
DLEP	Dynamic Link Exchange Protocol
DNS	Domain Name Service
DTIS	Digital Information Transfer System
FCI	Future Communications Infrastructure
FRD	Functional Requirements Document
G-G or G/G	Ground-to-Ground
ICAO	International Civil Aviation Organization
ID	Identifier
IEEE	Institute of Electrical and Electronics Engineers
IETF	Internet Engineering Task Force
IF	Interface
INV	Invariant
IP	Internet Protocol
IPS	Internet Protocol Suite
IPv4 / IPv6	Internet Protocol Version 4 or Version 6
L2 / L1	Layer 2 / Layer 1
LDACS	L Band Digital Aeronautical Communication System
lsb/LSB	Least Significant Bit
MAGIC	Manager of Air-Ground Interface Communications
Max	Maximum
MDE	Multilink Decision Engine
MIB	Management Information Base
MIH	Media Independent Handover

**ATTACHMENT 1
LIST OF ACRONYMS**

msb/MSB	Most Significant Bit
MTU	Maximum Transmission Unit
NSS	Network Server System
OMNI	Overlay Multilink Network Interface
PDP	Packet Data Protocol
QoS	Quality of Service
RCP	Required Communication Performance
RCTP	Required Communication Technical Performance
RF	Radio Frequency
RFC	Request for Comment
RSP	Required Surveillance Performance
RX	Receive
SAP	Service Access Point
Satcom	Satellite Communications
SB-Safety	Swift Broadband-Safety
SDO	Standards Development Organization
SDU	Satellite Data Unit
SESAR	Single European Sky Air Traffic Management (ATM) Research
SESAR JU	SESAR Joint Undertaking
Sn	Sequence Number
SNMP	Simple Network Management Protocol
TBC	To Be Confirmed
TBD	To Be Determined
TCP	Transmission Control Protocol
TLV	Type-Length-Value
TX	Transmit
UDP	User Datagram Protocol
VDLm2	VHF Data Link Mode 2
VDR	VHF Data Radio

**ATTACHMENT 2
GLOSSARY**

ATTACHMENT 2 GLOSSARY

Access Network

A network that is characterized by a specific access technology.

Air-Ground Access Network

Access network that provides air-ground communication services.

Air-Ground Datalink

Refer to the definition for Air-Ground Access Network.

Airborne IPS Host

Airborne instantiation of an IPS Host.

Airborne IPS Router

An airborne device that is used to support ATN/IPS packet forwarding between one or more Airborne IPS Hosts and Airborne Radios.

Airborne IPS System

The collection of airborne components and functions that provide IPS services.

Airborne Radio

Physical airborne radio that provides the communication over-the-air using the specific air-ground access network specification and the Layer 2 interface to the Airborne IPS System.

AOC – Aeronautical Operational Control

Communication required for the exercise of authority over the initiation, continuation, diversion, or termination of flight for safety, regularity, and efficiency reasons.

AOC – Airline Operational Control

Operational messages used between aircraft and airline dispatch centers or, by extension, the DoD to support flight operations. This includes, but is not limited to, flight planning, flight following, and the distribution of information to flights and affected personnel.

ATN/IPS

The set of technical provisions and standards that define the architecture and operation of Internet Protocol-based networking services. Also referred to as IPS.

ATN/IPS Network / System

Internetwork consisting of ATN/IPS nodes and networks operating in a multinational environment in support of Air Traffic Services (ATS) as well as aeronautical industry service communication such as Aeronautical Operational Control (AOC) and Aeronautical Administrative Communications (AAC).

**ATTACHMENT 2
GLOSSARY**

CIRI Endpoint

The functional element within an Airborne IPS System or an Airborne Radio that implements the Common IPS Radio Interface (CIRI) protocol.

Control Plane

Data exchanged to manage communication sessions between users. The control plane includes protocols providing information needed to move traffic from one device to another through the network. Routing protocols and Domain Name Service (DNS) belong to the control plane.

Data Plane

The collection of resources across all network devices responsible for forwarding traffic to the next hop along the path to the selected destination network according to the control plane logic.

Downlink

A unit of data sent from an aircraft to a ground-based system.

IPS (aka IPS for Safety Services)

Refer to the definition for ATN/IPS.

IPS Node

A device that implements IPv6. There are two types of IPS nodes: an IPS Host and an IPS Router. Note: An IPS Gateway could be considered an IPS Node.

IPS Router

A node that forwards Internet protocol (IP) packets not explicitly addressed to itself. A router manages the relaying and routing of data while in transit from an originating IPS Host to a destination IPS Host.

IPS System

The IPS System is the all-encompassing aviation internet that provides data transport, networking, routing, addressing, naming, mobility, multilink and information security functions to the aviation services. The IPS System includes the Layer 3 and Layer 4 functions of the ISO/IEC 7498-1 OSI 7-layer Reference Model. The IPS System does not include the underlying subnetwork functions that provide connectivity or the applications.

Link_degraded

A link technology-specific indication that link conditions are degrading, which may result in connection loss.

Link_down

A discrete event indicating that a Layer 2 connection is broken, and the link is unavailable.

Link_up

A discrete event indicating that a Layer 2 connection is established and the link is available.

ATTACHMENT 2
GLOSSARY

MDE – Multilink Decision Engine

A function which ensures that the multilink policy for the uplink or downlink traffic is loaded to the policy enforcement element to select the access network on a packet-by-packet basis.

Multilink

Ability to use all available air-ground access networks in order to provide the specified performance.

Network

A group of two or more devices (nodes) that communicate using a common set of communication protocols.

Network Layer

Protocol layer ensuring global routing over interconnected packet-switched communication networks.

Physical and Link Layers

Functions within the subnetworks that handle the physical interface with the transmission medium (i.e., radio links).

QoS – Quality of Service

A framework where the overall performance of an application or a computer network is stated. Examples of parameters are: Integrity, Availability, Delay, Continuity, bit rate, throughput, delay, etc.

Satcom – Satellite Communications

Communication service providing data, voice, and fax transmission via satellite. Allows aircraft to communicate in Beyond Line Of Sight (BLOS) areas.

SESAR – Single European Sky ATM Research

Technological pillar of the Single European Sky. It aims to improve Air Traffic Management (ATM) performance by modernizing and harmonizing ATM systems through the definition, development, validation, and deployment of innovative technological and operational ATM solutions.

Subnetwork

An actual implementation of a data network that employs a homogeneous protocol and addressing plan and is under control of a single authority.

Transport Layer

Protocol layer used to provide reliable or unreliable communication services over the IPS System. Those include Transmission Control Protocol (TCP) for reliable transport services and UDP that is used to provide best effort service.

Uplink

A unit of data sent from a ground-based system to an aircraft.

**APPENDIX A
CIRI PROTOCOL BACKGROUND**

APPENDIX A CIRI PROTOCOL BACKGROUND

The main body of this document provides the normative specification of the CIRI protocol for implementation by an Airborne IPS System and Airborne Radios. The informative material in this appendix should not be interpreted as normative and is provided solely as background information to explain the basis for the selection and characteristics of the CIRI protocol.

The information provided is based on work performed under the SESAR 14.2.4 project that summarized its results in Functional Requirements Document [FCI-FRD].

A-1 Common IPS Radio Interface Requirements

This section defines a set of requirements defining the needs of the Common IPS Radio Interface.

The following tables present control plane, data plane, flow control, and robustness requirements. Mandatory protocol requirements are identified using “shall” and recommendations are identified using “should” and italicized text.

Table A-1 – Control Plane Requirements

No.	Requirement	Note	CIRI Protocol Compliance
1	The Common IPS Radio Interface protocol shall enable the Airborne Radio to report datalink operational status to the Airborne IPS System.	At a minimum, distinguishing available (“link_up”) and not available (“link_down”)	Channel Status option
2	The Common IPS Radio Interface protocol shall be able to distinguish multiple different operational statuses.	For example, distinguishing between “link_up” and “link_degraded”. Although defining a fine-grained metric that would allow comparing “fitness” of datalinks of various technologies proves to be extremely difficult, ability to indicate a non-nominal, degraded performance is considered to be useful.	Distinguishes up to 7 distinct operational statuses
3	The Common IPS Radio Interface protocol shall enable the Airborne Radio to report operational status separately for multiple datalink channels when multiple channels are provided by the datalink.	The “Channel” identifies a subset of air-to-ground traffic that is treated by the Airborne Radio together. This is necessary to support Satcom operation described in Requirement 6, to distinguish status of the provided “higher-priority” (RCP/RSP-bound, e.g., ATS) and “lower-priority” (non-RCP/RSP-bound, e.g., AOC) channels. An Airborne Radio may provide and announce just single datalink channel that is used for all traffic.	Channel Status option Allows reporting status for up to 255 channels.
4	The Common IPS Radio Interface protocol shall enable the Airborne Radio to report the current access network identifier.	This information is necessary for the mobility and multilink signaling (e.g., AGMI).	Link Instance option The option is chosen such that the received Link Instance ID can

**APPENDIX A
CIRI PROTOCOL BACKGROUND**

No.	Requirement	Note	CIRI Protocol Compliance
		The “access network” identifies a combination of the datalink technology and a communication service provider. For example, a Link Instance ID as defined in the AGMI protocol. This information might be important for multilink selection in the aircraft.	be used directly in the AGMI protocol.

Table A-2 – Data Plane Requirements

No.	Requirement	Note	CIRI Protocol Compliance
5	The Common IPS Radio Interface protocol shall enable the Airborne Radio and the Airborne IPS System to exchange data-plane packets not exceeding 1280 bytes. Larger packets may be supported.	In other words, the MTU size of the data plane of the Common IPS Radio Interface must be 1280 bytes or larger. For this basic requirement, no special protocol would be needed.	Data-Plane message with Packet Data option
6	The Common IPS Radio Interface protocol shall enable the Airborne IPS System to indicate a datalink channel for air-to-ground packets passed to the Airborne Radio.	This is needed for safety-certified datalink operation that can simultaneously handle RCP/RSP-bound communication (higher priority/“ATS” traffic) and communication without RCP/RSP constraints (lower priority/“AOC” traffic). <ul style="list-style-type: none"> • The higher priority traffic needs this to satisfy the RCP/RSP even in the presence of uncontrolled traffic. • For example, Satcom is envisioned to provide dedicated underlying channels for the higher priority traffic and the lower priority traffic. The requirement could be satisfied by deploying multiple non-CIRI-based data-plane interfaces between the Airborne IPS System and the Airborne Radio. Typically, it is envisioned that two datalink channels are used, e.g., one for RCP/RSP-bound communication and one for communication without RCP/RSP constraints.	Channel Identifier option

Note that although the Requirements 5 and 6 and could be satisfied by one or more “plain” interfaces/channels for the data-plane packets; however, the Common IPS Radio Interface defines a more scalable and extensible alternative, in form of the data-plane CIRI message.

APPENDIX A
CIRI PROTOCOL BACKGROUND

Table A-3 – Flow Control Requirements

No.	Requirement	Note	CIRI Protocol Compliance
7	The Common IPS Radio Interface protocol shall enable the Airborne Radio to inform the Airborne IPS System about the number of bytes that it can accept in a traffic flow.	The “traffic flow” is a subset of air-to-ground traffic. See Requirements 8 and 9.	Flow control mechanism
8	The Common IPS Radio Interface protocol shall support multiple traffic flows, where each traffic flow consists of air-to-ground packets belonging to a single channel (as described in Requirement 3).	i.e., the protocol can provide flow control on a per-channel basis	Flow control mechanism
9	<i>The Common IPS Radio Interface protocol should support a traffic flow that consist of all air-to-ground packets (regardless of the channel).</i>	i.e., the protocol can provide flow control for all traffic together.	None. This optional feature was not included to simplify the flow control mechanism.

The operation of the flow control mechanism is also influenced by the following Robustness requirements.

Table A-4 – Robustness Requirements

No.	Requirement	Note	CIRI Protocol Compliance
10	The Common IPS Radio Interface protocol shall be robust against:		Flow control and/or stateless operation of the CIRI protocol
10.1	... Airborne IPS System restarts (losing its Common IPS Radio Interface-related runtime state)		
10.2	... Airborne Radio restarts (losing its Common IPS Radio Interface-related runtime state)		
10.3	... interleaved messages in opposite directions.	Case shown in the following diagram: 	
11	<i>The Common IPS Radio Interface protocol should be robust against change of message delivery order.</i>	This is assumed to be much a much less probable situation than the one described in Requirement 10.3.	CIRI protocol converges to a valid state with the next received CIRI message

**APPENDIX A
CIRI PROTOCOL BACKGROUND**

No.	Requirement	Note	CIRI Protocol Compliance
12	The Common IPS Radio Interface protocol shall allow future backward compatible extensions that interoperate with implementations of the older protocol version.		<p>CIRI header contains 3 reserved bits that are ignored by older implementations.</p> <p>New CIRI TLV options can be defined, which will be ignored by the older implementations.</p> <p>Most current CIRI options can be extended. The extra bytes will be ignored by the older implementations.</p> <p>CIRI options used in cases with undefined semantics are ignored.</p>
13	The Common IPS Radio Interface protocol shall allow future non-backward compatible versions.		CIRI header Version field will be incremented if this becomes necessary

Table A-5 – General Protocol Operation Requirements

No.	Requirement	Note	CIRI Protocol Compliance
14	The Common IPS Radio Interface protocol shall enable the Airborne IPS Systems to have up-to-date datalink status information from the Airborne Radio.	The "datalink status information" is defined by requirements in Section 4.3.1.	<p>CIRI request-response communication pattern allows the Airborne IPS System to fetch the current information after startup.</p> <p>CIRI "trap-like" unsolicited messages sent by the Airborne Radio convey changes in datalink status information without a delay.</p>
15	The Common IPS Radio Interface protocol shall enable the Airborne IPS System to detect loss of connection with the Airborne Radio.	This "health monitoring" detects when the Airborne Radio goes down or when the connection between the Airborne IPS System and the Airborne Radio is broken.	CIRI protocol assumes the Airborne Radio is "broken" if answers to consecutive requests are not received.

APPENDIX A
CIRI PROTOCOL BACKGROUND

A-2 Protocol Design**A-2.1 Key Principles**

The following bullets define key design principles for a Common IPS Radio Interface Protocol:

- The protocol should be as simple as possible.
 - Facilitates certification
 - Facilitates implementation
- The protocol should be as stateless as possible.
 - Facilitates recovery after restart of either peer.
- The protocol should not need any information from the lower layers (e.g., IP address, UDP port) to distinguish messages for/from different datalinks.

A-2.2 Flow Control Design Background

The proposed flow control design employs a *Flow Sequence – Flow Window* exchange mechanism to indicate the size of the flow window (i.e., credits for sending air-to-ground data). This approach is preferred over an alternative design in which the Airborne Radio indicates the absolute number of available credits. While this alternative approach may be simpler to implement and would work in most cases, an undesirable condition is possible when two protocol messages sent in opposite directions are interleaved, as shown in Figure A-1. As a consequence of such a scenario, the Airborne IPS System might send more data than the Airborne Radio is able to process in the given flow-controlled channel.

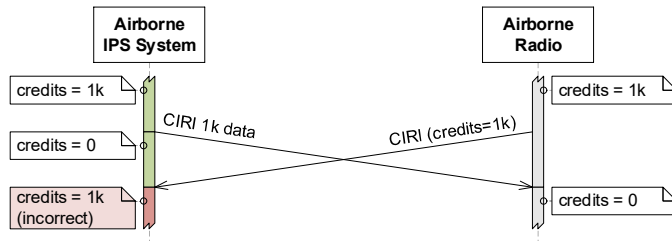

Figure A-1 – Alternative Credit-based Flow Control Mechanism: Interleaved Messages can Cause an Undesirable Condition

With the proposed *Flow Sequence/Flow Window* exchange mechanism illustrated in Figure A-2, this problem is mitigated since the number of credits is conveyed in terms of the highest allowed flow sequence for the given flow-controlled channel.

APPENDIX A
CIRI PROTOCOL BACKGROUND

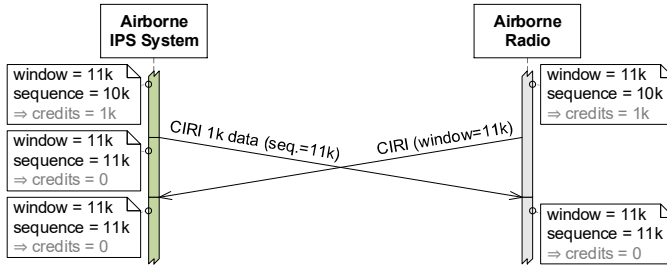

Figure A-2 – Proposed Sequence/Window-based Flow Control Mechanism: Interleaved Messages are Interpreted Correctly

To further improve robustness, the proposed flow control mechanism also includes the Sequence Number with every air-to-ground packet forwarded to the Airborne Radio. This mitigates an out-of-synchronization condition in the event that a message is lost.

A-3 Candidate Protocol Alternatives – Initial Assessment

The following alternatives were considered as implementation options for the Common IPS Radio Interface protocol.

A-3.1 Custom Layer 2 Protocol

Common IPS Radio Interface messages are implemented using a simple custom protocol that is carried directly by layer 2 (L2) frames (e.g., Ethernet) with no IP layer involved.

The main benefit of this approach is that it is lightweight – the Airborne Radio would not need an IPv6 network stack implementation. However, this approach is very nonstandard in the “TCP/IP” protocol suite, and consequently, this is the only alternative that does not use either a TCP/IP or UDP/IP stack.

A-3.2 Simple Network Management Protocol (SNMP)

This protocol is a de-facto industry standard, but it is (despite its name) rather complex and heavyweight. It offers configurable features (e.g., fine-grained access control, discovery procedure) while the Common IPS Radio Interface would only benefit from several specialized types of messages periodically sent between the peers.

To use SNMP for the Common IPS Radio Interface, it is necessary to know Management Information Base (MIB) and “operational protocol” – which party sends which message at which occasion, usage of SNMP requests/traps &c.

There are two [practical](#) options:

- Each Airborne Radio uses its own MIB with its own semantics
 - This is simple, as there is nothing to standardize
 - On the other hand, this approach leaves fundamental parts of the Common IPS Radio Interface operation unspecified. A considerable amount of radio-specific configuration, and possibly adaptation layer software, is needed for each Airborne Radio

**APPENDIX A
CIRI PROTOCOL BACKGROUND**

- Because this approach does not result in a “standardized Common IPS Radio Interface,” it is not further investigated in this document.
- There is a common MIB and standardized mode of operation supported by all compliant Airborne Radios
 - This is the preferred approach when using SNMP
 - The following must be standardized:
 - Common IPS Radio Interface MIB
 - SNMP configuration for Common IPS Radio Interface, e.g., configuration of the security model
 - Common IPS Radio Interface “operational protocol”

Consequently, defining the Common IPS Radio Interface protocol on top of SNMP necessitates further definition and standardization.

A-3.3 ARINC 839 MAGIC

Although ATN/IPS is not a MAGIC-complaint system per ARINC 839, the Common IPS Radio Interface bears similarity to the Common Link Interface specified in ARINC 839.

- The Common Link Interface is based on MIH_LINK_SAP from IEEE 802.21, which is not designed to operate between different nodes over a network.
- There is not any standard way to transfer MIH_LINK_SAP primitives over a network; however, IEEE 802.21 defines structure of MIH_LINK_SAP primitives and a serialization into a stream of bytes.
- MIH_LINK_SAP primitives are quite complex and hold lots of information. Only a fraction of the included information has been identified to bring a benefit to ATN/IPS environment.
- The purpose of MIH_LINK_SAP seems not to align with ATN/IPS needs well.
 - The MIH_LINK_SAP primitives are focused on commanding and controlling the “Data Link Module.”
 - Common IPS Radio Interface is used only to retrieve information about a datalink.

Note that any implementation of Common IPS Radio Interface messages can be treated as an implementation of a subset of MIH_LINK_SAP primitives (Link_Up, Link_Down, etc.).

A-3.4 TCP-based Data Plane Protocol

TCP was evaluated as an option for flow-control capable data plane for the Common IPS Radio Interface. TCP is quite complex and provides unnecessary functionality, like congestion control and retransmissions. Although Commercial Off The Shelf (COTS) solutions are available, the complexity of these solutions would make certification difficult.

Since TCP is a stream-oriented protocol, it would be necessary to define how the stream is constructed from and then split into a sequence of data-plane packets. This is a minor issue, but it highlights complexity of addressing this for Common IPS Radio Interface unnecessary functionality of the TCP.

**APPENDIX A
CIRI PROTOCOL BACKGROUND**

The COTS TCP flow control is driven purely by the receiver application (e.g., Airborne Radio) reading the packets from TCP queues. This would probably need to be changed, because the Airborne Radio needs to have better control of the flow window provided to the Airborne IPS System.

Additionally, at the transmitting endpoint, if a COTS implementation is to be used, the data waiting for a flow window are stored in the queues of the TCP implementation and out of control of the transmitter (e.g., Airborne IPS System), preventing implementation of most of the envisioned benefits of the flow control, such as rerouting and fine-grained prioritization within the Airborne IPS System.

A-3.5 Custom UDP-based Protocol – Common IPS Radio Interface Protocol (CIRI)

Common IPS Radio Interface messages are implemented using a simple custom protocol that is carried by UDP/IP. UDP adds little overhead in comparison to just IPv6 stack and provides a standard way to transport data payload.

The proposed protocol is simple and easy to implement. It is designed to be future-proof and can be easily extended with new “options.” While this requires the need to specify a new protocol, all of the other candidate protocols would also need a new standard (or a “profile”) specifying how the particular protocol should be used to satisfy identified requirements.

A-3.6 Candidate Protocol Summary

The following table provides a summary comparison of the candidate protocols described in this section.

Table A-6 – Protocol Comparison Matrix

Criteria	SNMP	MAGIC	Custom L2	TCP	Custom UDP (CIRI)
Control plane support	Yes	Yes	Yes	No	Yes
Data plane support	No	No	Yes	Yes	Yes
COTS layers	(L2) IPv6 UDP SNMP	(L2) IPv6 UDP or TCP	(L2)	(L2) IPv6 TCP (modified)	(L2) IPv6 UDP
To be specified / standardized	Operation, MIB	Transport, operation	Transport, operation, message format	Operation	Transport, operation, message format
To be implemented	Operation, MIB	Operation	Operation, message format	TCP modifications	Operation, message format
Protocol complexity	High	High	Low	High	Low
Approach commonality	High	Medium	Low	High	Medium
Certification complexity	High	High	Medium	High	Medium

Although the transport, protocol operation, and message format must be specified for the Custom UDP (CIRI) protocol, the low protocol complexity also minimizes the complexity of the standardization effort, as conveyed in the body of this document.

A-4 Candidate Protocol Alternatives – Secondary Assessment

Subsequent to the candidate assessment presented in A-3, the Dynamic Link Exchange Protocol (DLEP), per RFC 8175, was also assessed as a potential radio interface protocol. DLEP is designed to communicate datalink characteristics

**APPENDIX A
CIRI PROTOCOL BACKGROUND**

between a “modem” and a “router,” which matches the nature of the Common IPS Radio Interface. However, it diverges somewhat from the needs of the IPS. For example:

- DLEP assumes the possibility of multiple “destinations” directly reachable through the managed datalink, and datalink characteristics can be specified per-destination.
- DLEP can be used to indicate IP addresses and subnets assigned to destinations, possibly replacing Neighbor Discovery on the link.
- DLEP also supports plug-and-play style deployment, where the router can discover modems and then the peers negotiate used parameters for DLEP session.

Because DLEP, including standardized extensions, does not elegantly provide all features per the Common IPS Radio Interface requirement, an option of using DLEP with a custom extension is also evaluated.

A-4.1 Comparison Overview

The following tables compare characteristics and the ability to meet the CIRI requirements specified in Section A-1 of this appendix.

Table A-7 – Basic Characteristics

Characteristic	Custom UDP (CIRI)	DLEP (COTS)	DLEP + custom extensions
Peering	Preconfigured	Possibly plug-and-play	Possibly plug-and-play
Transport	UDP	TCP	TCP
COTS	No	Yes	No

Table A-8 – Ability to Meet CIRI Requirements

Requirement per Section A-1		Custom UDP (CIRI)	DLEP (COTS)	DLEP + custom extensions
No.	Short Description			
1	Report datalink operational status	Yes	Yes	Yes
2	Multiple different operational statuses	Yes (7)	Yes (99)	Yes (99)
3	Separate operational status for multiple datalink channels	Yes	Only using ugly hacks	Yes (custom extension needed)
4	Report current access network identifier	Yes	No	Yes (custom extension needed)
5, 6	Data plane	Yes	No	No
7	Flow control	Yes	Yes (only pause/resume)	Yes (only pause/resume)
8	Flow control: flow per datalink channel	Yes	Only using ugly hacks	Yes (custom extension needed)
9	[optional] Flow control: one universal flow	No	Yes	Yes
10.1, 10.2	Robustness against restarts	Yes	Yes	Yes
10.3	Robustness against interleaved messages in opposite directions	Yes	Yes	Yes
11	[optional] Robustness against change of message delivery order	Partial	Yes	Yes

**APPENDIX A
CIRI PROTOCOL BACKGROUND**

Requirement per Section A-1		Custom UDP (CIRI)	DLEP (COTS)	DLEP + custom extensions
No.	Short Description			
12	Support for future backward compatible extensions	Yes	Yes	Yes
13	Support for future non-backward compatible versions	Yes	Yes	Yes
14	Timely delivery of status information	Yes	Yes	Yes
15	Radio health monitoring	Yes	Yes	Yes

A-4.2 DLEP Profile for the Common IPS Radio Interface

In the context of DLEP, the Airborne Radio is a DLEP “modem,” and the Airborne IPS System is a DLEP “router.”

A-4.2.1 Signaling Datalink Status (Requirements 1 and 2)

The Airborne Radio indicates, in the Session Initialization Response Message and in subsequent Session Update Messages, datalink status using DLEP Data Items Relative Link Quality (Receive) and Relative Link Quality (Transmit). Relative Link Quality 0 indicates “datalink not operational,” other values indicate “datalink operational.” Relative Link Quality 100 should indicate the nominal operational performance (“link_up”), other values can be used for non-nominal performance (e.g., “link_degraded”).

A-4.2.2 Signaling Status for Multiple Datalink Channels (Requirement 3)

DLEP, including currently standardized extensions, does not provide a clean way to signal separate sets of parameters for multiple channels provided by the datalink. Several options are described in the following sub-sections.

A-4.2.2.1 Option 1: Separate DLEP Sessions

One option is to establish a dedicated DLEP session for each channel, effectively treating them as separate datalinks. This is probably the cleanest option achievable with currently standardized DLEP, but this approach has a significant impact on Mobility and Multilink signaling (i.e., the AGMI protocol).

A-4.2.2.2 Option 2: Abusing DLEP Destinations

Another option would be to treat datalink channels as DLEP “destinations” and signal the *Relative Link Quality* for these destinations. DLEP destinations are identified using MAC addresses, so it would be necessary to define a special MAC address for each supported datalink channel. Alternatively, channel-specific destinations may use a single common MAC address in combination with channel-specific Link Identifier as introduced by the DLEP Link Identifier Extension.

A-4.2.2.3 Option 3: Custom DLEP Extension

The third option would be to develop a custom DLEP extension to define, for example, the following new channel-specific messages to signal relative link quality:

- Channel Up Message
- Channel Up Response Message
- Channel Update Message
- Channel Update Response Message

**APPENDIX A
CIRI PROTOCOL BACKGROUND**

- Channel Down Message
- Channel Down Response Message
- Channel Identifier Data Item (present in every Channel * Message)

This option may be best, but it defeats the benefit of using a COTS protocol.

A-4.2.3 Reporting Auxiliary Information (Requirement 4)

DLEP does not provide a way to communicate auxiliary datalink information as is Access network identifier (Link instance ID). However, it would be straightforward to define a DLEP extension to convey such information.

A-4.2.4 Data Plane (Requirements 5 and 6)

DLEP is not intended to handle data-plane traffic, so another interface must be used for the data plane. Note that the data plane must identify a “datalink channel” for each air-to-ground data-plane packet.

A-4.2.5 Flow Control (Requirements 7, 8, and 9)

The Control-Plane-Based Pause DLEP Extension (per RFC 8651) provides a simple flow control mechanism. The Airborne Radio declares a set of “queues,” where each queue is defined by a set of DSCPs, and at any point in time, the Airborne Radio can instruct the Airborne IPS System to “pause” data-plane flow for any declared queue. The “pause” instruction can be issued for the entire DLEP session, or per DLEP destination. So, this mechanism is compatible with both Option 1 and Option 2 described in Sections A-4.2.2.1 and A-4.2.2.2, respectively.

Note that although this mechanism might be sufficient, it is subject to some race conditions, e.g., the radio may receive data-plane packets after sending the pause message. For comparison, flow control in CIRI allows the Airborne Radio to indicate how much data (in bytes) the radio can accept from the Airborne IPS System, ensuring that the Airborne Radio never receives more air-to-ground data than it can handle.

A-4.2.6 Robustness (Requirements 10, 11, 12, and 13)

Because the DLEP uses TCP connection, then restart of any peer inherently leads to establishment a new DLEP session. TCP also prevents ordering issues within the DLEP session. On the other hand, because the data plane is not handled by DLEP, there are still some possible outstanding ordering issues (see the race condition described in Section A-4.2.5.)

DLEP uses TLV to encode information (similar to the CIRI protocol) providing sufficient room for future backwards-compatible extensions. DLEP also employs an extension negotiation procedure at the beginning of every DLEP session. Although this increases the complexity of the protocol implementation, it may further facilitate incremental deployment of future extensions.

A-4.2.7 General Operation (Requirements 14 and 15)

The Airborne Radio sends a DLEP message (Session Update Message or another, see Section 3.2) immediately after detecting change of datalink status, ensuring the timely delivery of the status information. In the absence of other messages, DLEP endpoints periodically send a Heartbeat Message, enabling detection of loss of a DLEP peer.

**APPENDIX A
CIRI PROTOCOL BACKGROUND**

A-4.3 DLEP Comparison Summary

The Common IPS Radio Interface protocol, as specified in the main body of this document, is recommended over DLEP. The rationale for this recommendation includes:

- DLEP uses TCP transport, and there have been strong objections against specifying the use of TCP for IPS, particularly in the avionics implementations (e.g., similar discussion regarding Enrolment over Secure Transport protocol for certificate enrolment)
- A COTS instance of DLEP does not fully meet the Common IPS Radio Interface requirements; therefore, custom extensions are necessary to address the gaps
- DLEP with custom extensions detracts from the attractiveness of being a COTS solution
- Compared to the DLEP, the CIRI protocol is simple and lightweight, which is especially attractive for the Airborne Radio implementation
- As part of IPS prototyping and validation activities, the CIRI protocol has been implemented by multiple Airborne Radio suppliers and validated in both the lab environment as well as during flight tests