

**ARINC SPECIFICATION 858 PART 2
TABLE OF CONTENTS**

1.0	INTRODUCTION.....	1
1.1	Purpose.....	1
1.2	Scope.....	1
1.3	Document Overview.....	3
1.3.1	Multi-part Specification Organization.....	3
1.3.2	Part 2 Document Organization.....	3
1.4	Related Documents.....	4
1.4.1	Relationship of this Document to Other ARINC Standards.....	4
1.4.2	Relationship to Other Industry Standards.....	5
1.5	Regulatory Approval.....	7
1.6	Export Control Compliance.....	7
2.0	DATA COMMUNICATIONS ENVIRONMENT OVERVIEW.....	9
2.1	Introduction.....	9
2.2	Current Environment.....	9
2.3	Transition to IPS.....	10
3.0	IPS GATEWAY FUNCTION.....	12
3.1	Transition-driven Considerations.....	12
3.2	Primary Use Cases.....	13
3.3	Functional Description.....	14
3.4	IPS Gateway Functional Requirements.....	15
3.4.1	Operational Associations.....	15
3.4.2	State Mapping.....	16
3.4.3	Protocol Conversion.....	17
3.4.4	Security.....	18
3.4.5	Additional Support Services.....	18
3.5	Deployment Considerations.....	18
3.6	Performance and Safety Considerations.....	19
4.0	IPS GATEWAY FOR ACARS.....	20
4.1	Principle of Operation.....	20
4.2	Ground Address Acquisition.....	21
4.3	Mapping of ARINC 620 Messages to the AICF Interface.....	21
4.3.1	Downlink Message Conversion.....	21
4.3.2	Uplink Message Conversion.....	23
4.4	State Tables.....	24
4.4.1	Air-Initiated Applications.....	25
4.4.2	Ground-Initiated Applications.....	26
4.5	Message Exchange Examples.....	31
4.5.1	FANS-1/A AFN Application Example.....	32
4.5.2	FANS-1/A CPDLC Application Example.....	33
4.5.3	FANS-1/A Multi-ANSP Example.....	35
4.5.4	FANS-1/A CPDLC Application Uplink Failure Example.....	36
5.0	IPS GATEWAY FOR OSI.....	38
5.1	Principle of Operation.....	38
5.2	Advertisement of Proxy Address.....	38
5.2.1	General Case.....	38
5.2.2	Context Management Application Considerations.....	40
5.3	Mapping of Dialogue Service Primitive Parameters.....	41
5.4	State Tables.....	45
5.4.1	Air-Initiated Applications.....	45

**ARINC SPECIFICATION 858 PART 2
TABLE OF CONTENTS**

5.4.1.1	IPS Aircraft Communicating with a Ground ATN/OSI End System	45
5.4.1.2	ATN/OSI Aircraft Communicating with a Ground IPS Host	47
5.4.2	Ground-initiated Applications	48
5.4.2.1	Ground ATN/OSI End System Communicating with an IPS Aircraft	49
5.4.2.2	Ground IPS Host Communicating with an ATN/OSI Aircraft	50
5.5	Message Exchange Examples	51
5.5.1	Air-Initiated CM Logon Example	52
5.5.1.1	IPS Aircraft Communicating with a Ground ATN/OSI End System	52
5.5.1.2	ATN/OSI Aircraft Communicating with a Ground IPS Host	54
5.5.2	Ground-Initiated ATN Application Example	55
5.5.2.1	Ground ATN/OSI End System Communicating with an IPS Aircraft	55
5.5.2.2	Ground IPS Host Communicating with an ATN/OSI Aircraft	57
ATTACHMENT 1	LIST OF ACRONYMS	61
ATTACHMENT 2	GLOSSARY	64

1.0 INTRODUCTION

1.0 INTRODUCTION

1.1 Purpose

Airlines and other users of the airspace rely on safe, secure, and reliable data communication services to meet their day-to-day operational needs. Air Navigation Service Providers (ANSPs) and data communication service providers must deliver these services globally and meet internationally recognized standards for communications performance.

The International Civil Aviation Organization (ICAO) Global Air Navigation Plan (GANP) and the European Union (EU) and United States (US) Air/Ground Data Communications Strategy identify a globally harmonized target aviation communications environment that includes a communication infrastructure based on selected commercial Internet Protocol (IP) standards. ICAO refers to this aviation communication network as the Aeronautical Telecommunication Network using the Internet Protocol Suite (ATN/IPS¹). The ATN/IPS network will be implemented in aircraft and in ground infrastructure to support safety-related services, including Air Traffic Services (ATS) and Aeronautical Operational Control (AOC). The ATN/IPS network infrastructure is considered the successor to the Airline Communications Addressing and Reporting System (ACARS) and to the ICAO-defined network infrastructure based on the Open Systems Interconnection (OSI) model, referred to as ATN/OSI.

The AEEC coordinated the development of this IPS Gateway Air-Ground Interoperability standard with ICAO, EUROCAE, and RTCA to identify interdependencies and ensure consistency among the ATN/IPS-related industry standards developed by these organizations.

1.2 Scope

Since the end-state goal for ICAO and the aviation industry is an aviation network communication infrastructure based on IPS, the transition strategy for achieving that end state is critical to the success of IPS adoption. For FANS-1/A users, which include oceanic and remote airspace as well as an increasing number of domestic enroute programs, the challenge is transitioning from ACARS network protocols to IPS. For domestic Europe, which uses the B1 application set (with a planned upgrade to the B2 application set) over OSI protocols, the challenge is transitioning from OSI to IPS.

“Big bang” approaches do not tend to work in aviation given the large numbers of aircraft equipped with legacy systems, the numbers of ground systems that need to change in short order, and the international operation of many aircraft. Changing aircraft equipment is expensive and time consuming. And ideally, the ANSPs should not be required to continually upgrade ground systems or implement duplicate networks to deal with different aircraft configurations.

For network protocol compatibility, the desired outcome is the ability of the protocol to meet the performance and delivery requirements for the provided services. Since the network protocol should largely be invisible to the end user, as long as

¹ In this document the term “ATN” is used to refer generically to the Aeronautical Telecommunications Network and could be either ATN/IPS or ATN/OSI. Furthermore, if only “IPS” is used, this is considered equivalent to referring to “ATN/IPS”.

1.0 INTRODUCTION

application compatibility is maintained, the main concern then becomes how to make different network technologies interoperate with minimal impact to systems on the aircraft and on the ground. Since the introduction of IPS-enabled avionics and ground systems is expected to happen over an extended time period, the IPS-based systems will need to be interoperable with existing ACARS and ATN/OSI aircraft and ground systems. Accommodation of IPS during the transition period will be accomplished via ground-based IPS Gateways, and the gateway architecture and functional requirements are described in this document.

Figure 1-1 illustrates the ATN/IPS near-term context showing the overlay of IPS Gateways in the current (at the time of this writing) communications environment where IPS-enabled aircraft and existing aircraft co-exist with combinations of existing and IPS-enabled ground systems.

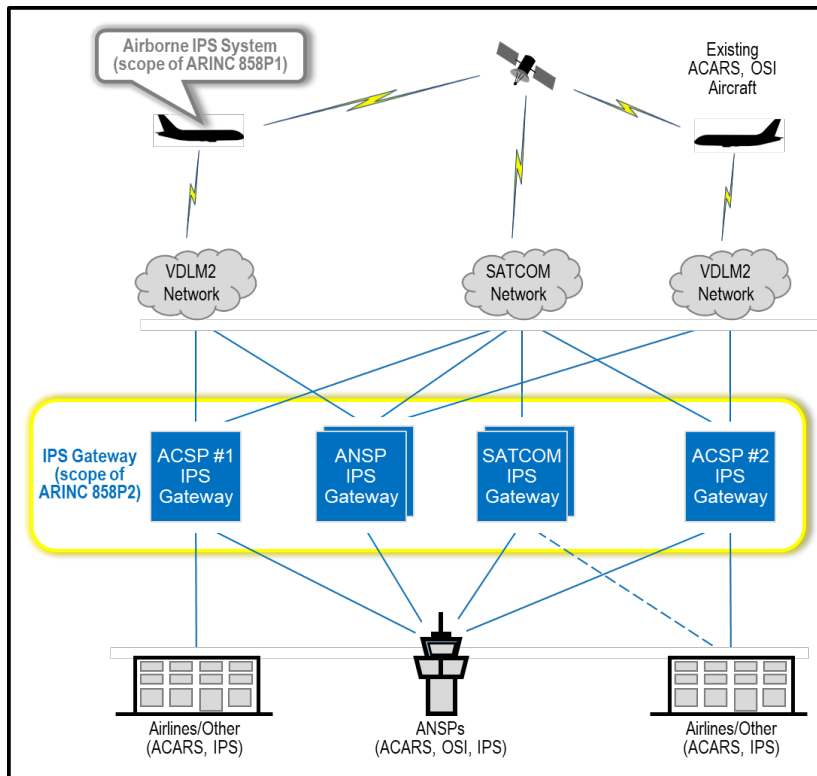

Figure 1-1 – IPS Gateways Overlaid on Current Environment

Note that this figure does not intend to illustrate the various ground administrative domains, but rather it is intended to show flexibility to accommodate various IPS Gateway deployment options, e.g., placement at an Air-Ground Communication Service Provider (ACSP) access network, at an ANSP, etc.

1.0 INTRODUCTION

The intent of this document, in coordination with other related industry standards, is to provide implementers of the IPS Gateway with the level of detail necessary to interoperate securely with Airborne IPS Systems and with other ground systems.

1.3 Document Overview

1.3.1 Multi-part Specification Organization

ARINC 858 is published as a multi-part document specification that includes the following documents:

- Part 1 – Airborne IPS System Technical Requirements
- Part 2 (this document) – IPS Gateway Air-Ground Interoperability
- **Part 3 – Common Radio Interface Protocol.**

1.3.2 Part 2 Document Organization

This document is organized as follows:

- Section 1.0 – Introduction
This section introduces the purpose and scope of this document, identifies related reference documents, and provides guidance for regulatory and export control compliance.
- Section 2.0 – Data Communications Environment Overview
This section presents an overview of the data communications environment at the time of this writing and introduces the role of the IPS Gateway during the transition to IPS.
- Section 3.0 – IPS Gateway Function
This section provides a functional description of the IPS Gateway based on primary use cases derived from transition-driven considerations. It further specifies the IPS Gateway functional requirements and includes performance and safety considerations.
- Section 4.0 – IPS Gateway for ACARS
This section describes the principle of operation, message mapping, and state tables for an IPS Gateway that enables ACARS application messages to be exchanged between an IPS Aircraft and a Ground ACARS Host. Detailed examples illustrate the role of the IPS Gateway for various air-initiated and ground-initiated ACARS-based applications.
- Section 5.0 – IPS Gateway for OSI
This section describes the principle of operation, message mapping, and state tables for an IPS Gateway that enables OSI-based application messages to be exchanged between an IPS Host (airborne or ground) and an OSI End System (ground or airborne). Detailed examples illustrate the role of the IPS Gateway for various air-initiated and ground-initiated OSI-based applications.
- Attachment 1 – List of Acronyms
This attachment provides a list of acronyms used in this document.
- Attachment 2 – Glossary
This attachment explains the precise meaning of terms used in this specification to avoid ambiguity and confusion.

1.0 INTRODUCTION

1.4 Related Documents

ATN/IPS as a whole represents a broad range of functions and components. These necessarily span many different standards development organizations (SDOs). Figure 1-2 illustrates high-level, exemplar relationships between ARINC 858 and ICAO standards, RTCA/EUROCAE standards, and other ARINC Standards. At a high level, the top row of standards make use of underlying IPS services, with adaptation provided by IPS as necessary so that existing interfaces are not impacted. The bottom row of standards represents functions to which the IPS service interfaces or uses; note that updates to these existing standards may be required to accommodate IPS-specific functions or interfaces. The ICAO and RTCA/EUROCAE standards on the same level as ARINC 858 define the global interoperability requirements necessary for IPS to support aeronautical safety services.

COMMENTARY

The Ku and Ka band Satcom standards are shown with a dashed line since these links do not operate in protected spectrum and are not approved for safety services communications. However, to facilitate commonality, interactions with these standards may still be of interest.

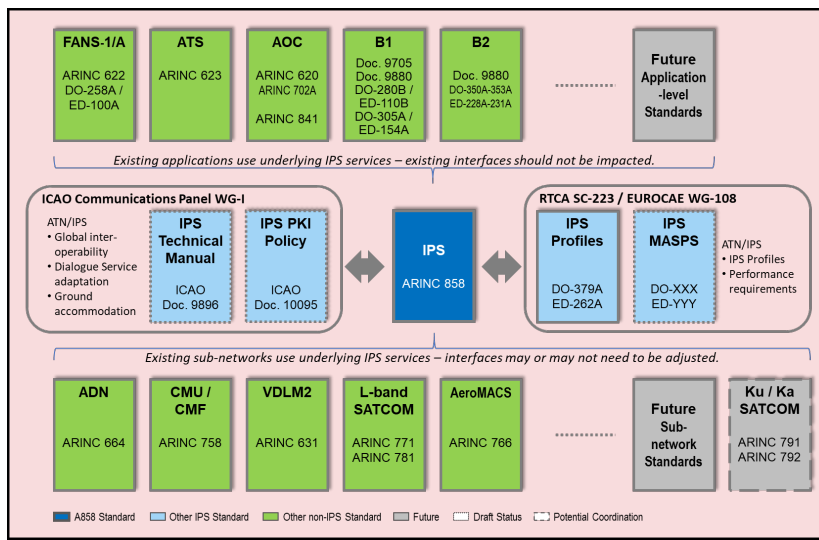

Figure 1-2 – Standards Relationships to ARINC 858

1.4.1 Relationship of this Document to Other ARINC Standards

ARINC Standards related to this specification are listed below, and the reader should ascertain the latest applicable version. When avionics systems and subsystems are designed to use the capabilities provided by this specification, they should incorporate the provisions of this specification by reference. References to this specification should assume the application of the latest applicable version.

Commented [OML1]: [P1-501-01 – M.Olive] - Update references for ICAO and RTCA/EUROCAE documents that are in draft status.
NOTE: Same in Part 1.
NOTE: Subject to decision on previous comment.

Commented [OML2]: Ed. Note – This intro material is a repeat of Part 1. Consider deleting from Part 2 to minimize document configuration management and potential for mis-alignment between parts.

Commented [OML3]: Ed. Note – Consider moving this text regarding 858 to last paragraph of Section 1.4 (i.e., just prior to 1.4.1).
NOTE: Whatever is decided, same in Part 1.

1.0 INTRODUCTION

ARINC Specification 618: *Air/Ground Character-Oriented Protocol Specification*

ARINC Specification 619: ACARS Protocols for Avionic End Systems

ARINC Specification 620: *Datalink Ground Systems Standard and Interface Design Specification (DGSS/IS)*

ARINC Specification 622: *ATS Data Link Applications over ACARS Air-Ground Network*

ARINC Specification 623: *Character-Oriented Air Traffic Service (ATS) Applications*

ARINC Specification 653: Avionics Application Software Standard Interface

ARINC Characteristic 702A: *Advanced Flight Management Computer System*

ARINC Specification 858: *Internet Protocol Suite (IPS) for Aeronautical Safety Services, Part 1, Airborne IPS System Technical Requirements*

1.4.2 Relationship to Other Industry Standards

The following list identifies related industry documentation referenced in this document. **The version cited was available at the time of this writing, and the reader should ascertain the latest applicable version.**

EUROCAE

- **ED-100A:** *Interoperability Requirements Standard for ATS Applications Using ARINC 622 Data Communications*. Also published as RTCA DO-258A.
- **ED-110B:** *Interoperability Requirements Standard for Aeronautical Telecommunication Network Baseline 1 (Interop ATN B1)*. Also published as RTCA DO-280B.
- **ED-120:** *Safety and Performance Requirements Standard for Initial Air Traffic Data Link Services in Continental Airspace*. Also published as RTCA DO-290.
- **ED-122:** *Safety and Performance Standard for Air Traffic Data Link Services in Oceanic and Remote Airspace (Oceanic SPR Standard)*. Also published as RTCA DO-306.
- **ED-154A:** *Future Air Navigation System 1/A – Aeronautical Telecommunication Network Interoperability Standard (FANS 1/A – ATN B1 Interop Standard)*. Also published as RTCA DO-305A.
- **ED-228A:** *Safety and Performance Requirements Standard for Baseline 2 ATS Data Communications (Baseline 2 SPR Standard)*. Also published as RTCA DO-350A.
- **ED-229A:** *Interoperability Requirements Standard for Baseline 2 ATS Data Communications (Baseline 2 Interop Standard)*. Also published as RTCA DO-351A.
- **ED-230A:** *Interoperability Standard for Baseline 2 ATS Data Communications, FANS1/A Accommodation*. Also published as RTCA DO-352A.

1.0 INTRODUCTION

- **ED-231A:** *Interoperability Requirements Standard for Baseline 2 ATS Data Communications, ATN Baseline 1 Accommodation (ATN Baseline 1 - Baseline 2 Interop Standard)*. Also published as RTCA DO-353A.
- **ED-262A:** *Technical Standard for Aviation Profiles for Internet Protocol Suite*. Also published as RTCA DO-379A.

Note: The following EUROCAE document is in draft status as of the time of this writing. Availability of a mature document and assigned document number are expected coincident with Supplement 1 of this document.

- **ED-YYY:** *Minimum Aviation System Performance Standard (MASPS) for the Internet Protocol Suite used in Aviation Air-Ground Communication Systems*. Also published as RTCA DO-XXX.

International Civil Aviation Organization (ICAO)

- **ICAO Doc. 9705-AN/956:** *Manual of Technical Provisions for the Aeronautical Telecommunications Network*
Note: ICAO Doc. 9705 has been superseded by ICAO Doc. 9880. Although ICAO Doc. 9880 serves as the primary reference, existing implementations may still reference the predecessor ICAO Doc. 9705 document.
- **ICAO Doc. 9750-AN/963:** *The Global Air Navigation Plan*
- **ICAO Doc. 9880-AN/466:** *Manual on Detailed Technical Specifications for the Aeronautical Telecommunication Network (ATN) using the ISO/OSI Standards and Protocols*
- **ICAO Doc. 10037-AN/509:** *Global Operational Data Link (GOLD) Manual*

Note: The following ICAO documents are in draft status as of the time of this writing. Availability of mature documents is expected coincident with Supplement 1 of this document.

- **ICAO Annex 10, Volume III:** *Aeronautical Telecommunications – Communication Systems*
- **ICAO Doc. 9896:** *Manual for the Aeronautical Telecommunication Network (ATN) using Internet Protocol Suite (IPS) Standards and Protocols*

RTCA

- **DO-258A:** *Interoperability Requirements Standard for ATS Applications Using ARINC 622 Data Communications*. Also published as EUROCAE ED-100A.
- **DO-280B:** *Interoperability Requirements Standard for Aeronautical Telecommunication Network Baseline 1 (Interop ATN B1)*. Also published as EUROCAE ED-110B.
- **DO-290:** *Safety and Performance Requirements Standard for Initial Air Traffic Data Link Services in Continental Airspace*. Also published as EUROCAE ED-120.
- **DO-305A:** *Future Air Navigation System 1/A – Aeronautical Telecommunication Network Interoperability Standard (FANS 1/A – ATN B1 Interop Standard)*. Also published as EUROCAE ED-154A.

1.0 INTRODUCTION

- **DO-306:** *Safety and Performance Standard for Air Traffic Data Link Services in Oceanic and Remote Airspace (Oceanic SPR Standard)*. Also published as EUROCAE ED-122.
- **DO-350A:** *Safety and Performance Requirements Standard for Baseline 2 ATS Data Communications (Baseline 2 SPR Standard)*. Also published as EUROCAE ED-228A.
- **DO-351A:** *Interoperability Requirements Standard for Baseline 2 ATS Data Communications (Baseline 2 Interop Standard)*. Also published as EUROCAE ED-229A.
- **DO-352A:** *Interoperability Standard for Baseline 2 ATS Data Communications, FANS1/A Accommodation*. Also published as EUROCAE ED-230A.
- **DO-353A:** *Interoperability Requirements Standard for Baseline 2 ATS Data Communications, ATN Baseline 1 Accommodation (ATN Baseline 1 - Baseline 2 Interop Standard)*. Also published as EUROCAE ED-231A.
- **DO-379A:** *Technical Standard for Aviation Profiles for Internet Protocol Suite*. Also published as EUROCAE ED-262A.

Note: The following RTCA document is in draft status as of the time of this writing. Availability of a mature document and assigned document number are expected coincident with Supplement 1 of this document.

- **DO-XXX:** *Minimum Aviation System Performance Standard (MASPS) for the Internet Protocol Suite used in Aviation Air-Ground Communication Systems*. Also published as EUROCAE ED-YYY.

Single European Sky Air Traffic Management Research Joint Undertaking (SESAR JU)

- *European Union and United States Air/Ground Data Communications Strategy, Version 3.00, 7 November 2017*. Published jointly with the US FAA.

US Federal Aviation Administration (FAA)

- *European Union and United States Air/Ground Data Communications Strategy, Version 3.00, 7 November 2017*. Published jointly with the European SESAR Joint Undertaking.

1.5 Regulatory Approval

This standard, in and of itself, will not ensure regulatory approval. Implementers are urged to obtain all information necessary for regulatory approval and work in close coordination with the appropriate regulatory authorities to gain certification as applicable.

1.6 Export Control Compliance

National and international laws regulate the export of products (e.g., systems, software, and technology) containing cryptography. These laws may require that an export license be obtained for any products containing cryptography, or they may impose restrictions on specific security controls (e.g., encryption) and cryptographic strength. The applicability of these laws depends on many factors including, but not

Commented [OML4]: Ed. Note – Published document title is "Internet Protocol Suite Profiles" which is different than ED-262. Coordinating with RTCA to harmonize -- title must first be changed in TOR, with PMC approval.

Commented [OML5R4]: RTCA PMC agreed to use EUROCAE title.

1.0 INTRODUCTION

limited to where the product is developed, where and to whom the product will be delivered, and how and by whom the product will be used.

This standard, in and of itself, will not ensure compliance with national and international export control laws. Implementers are urged to obtain all information necessary to comply with applicable export control laws.

COMMENTARY

The Wassenaar Arrangement (<https://www.wassenaar.org/>), which began in September 1996, is a multi-lateral agreement that attempts to harmonize export controls, including controls applicable to encryption technology, among countries participating in the agreement.

2.0 DATA COMMUNICATIONS ENVIRONMENT OVERVIEW

2.0 DATA COMMUNICATIONS ENVIRONMENT OVERVIEW

2.1 Introduction

ARINC Specification 858 Part 1 (Section 2.0) provides a high-level introduction to the overall IPS System, including: the end-to-end architecture; IPS functions and protocols; deployment and transition considerations; and assumptions and constraints. This document assumes that the reader is familiar with the overall IPS System context.

2.2 Current Environment

The current air/ground datalink communications environment (at the time of this writing) uses two aviation-unique networks:

- Aircraft Communications Addressing and Reporting System (ACARS) and
- Aeronautical Telecommunications Network using Open Systems Interconnection (ATN/OSI).

The general context of the current environment is shown in Figure 2-1.

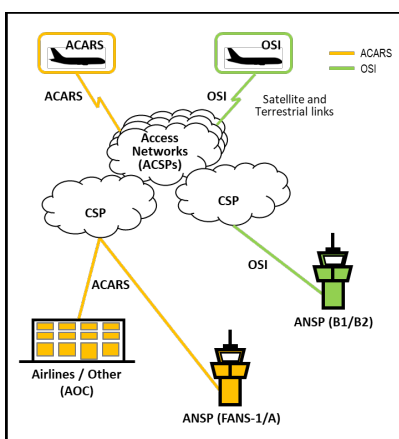

Figure 2-1 – Current Air-Ground Communications Environment

ACARS is the air-ground data communications infrastructure system that supports message exchanges between an aircraft and Air Traffic Control (ATC), national aviation authorities, and the aircraft's airline operation center. Billions of Air Traffic Control (ATC) and Airline Operational Control (AOC) messages are exchanged using ACARS every year. ACARS uses aviation-unique, character-oriented, air-ground communications protocols (per ARINC Specifications 618, 619, and 620) to exchange messages no larger than approximately 3.5 kilobytes over VHF, HF, and Satcom air-ground access networks. ACARS-based applications include:

- FANS-1/A Aeronautical Facilities Notification (AFN), Controller Pilot Data Link Communications (CPDLC), and Automatic Dependent Surveillance-Contract (ADS-C) application messages per ARINC 622
- Character-oriented ATS messages per ARINC 623
- AOC messages per ARINC 620 and ARINC 702A.

2.0 DATA COMMUNICATIONS ENVIRONMENT OVERVIEW

The ATN/OSI is an aeronautical data network used to carry ATC communications. ATN/OSI uses an aviation-unique, bit-oriented network protocol stack based on the Open Systems Interconnection (OSI) model as specified in ICAO Doc. 9880 (and predecessor ICAO Doc. 9705 Edition 2). ATN/OSI can operate over a variety of compliant air-ground access networks (e.g., VDLM2, with Inmarsat SBB testing in progress). Supported B1 and B2 applications include CM, CPDLC, and ADS-C (which is not deployed at the time of this writing).

2.3 Transition to IPS

Since introduction of IPS avionics and Ground IPS Systems is expected to happen over an extended time period, these systems will need to interoperate with existing ACARS and ATN/OSI aircraft and ground systems. In this environment, aircraft may have dual network protocol stacks for ATN and ACARS operation (e.g., ATN/OSI+ACARS or ATN/IPS+ACARS). However, ground systems may support only a single network stack (e.g., OSI or IPS). Therefore, ground-based IPS Gateways are necessary to facilitate interoperability. These gateways, which may be implemented by ground endpoint systems or by third-party service providers such as Air-Ground Communications Service Providers (ACSPs), represent a key part of the transition path to full IPS. The IPS Gateways support the following communications modes:

- IPS aircraft interoperating with a legacy facility (ATN/OSI or ACARS)
- Legacy aircraft (ATN/OSI, ACARS) interoperating with a Ground IPS Host

Given a heterogeneous network protocol environment, the interoperability need driving the ground architecture is illustrated in Figure 2-2.

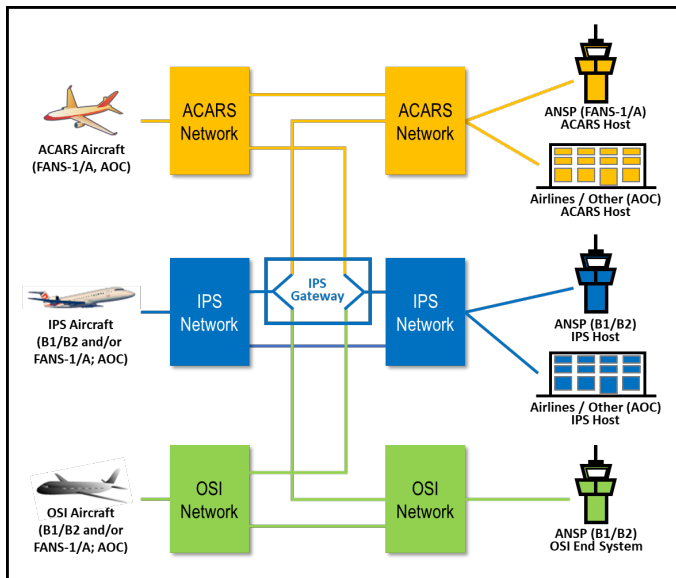

Figure 2-2 – Ground IPS System Architecture Drivers

2.0 DATA COMMUNICATIONS ENVIRONMENT OVERVIEW

The key point of the figure above is that gateway functionality is needed if one side (either the aircraft or ground endpoint system) is IPS-enabled. The ultimate end-state is a full ATN/IPS network. In this environment any IPS Aircraft can communicate directly through the ATN/IPS network to a Ground IPS Host.

The ATN/IPS network is exclusively intended to provide data communications services to ATS provider organizations and aircraft operating agencies. An ATN/IPS network is managed by an administrative domain – an organizational entity which can be an individual State, a group of States (e.g., an ICAO region or a regional organization), an Air-Ground communications service provider (ACSP), an air navigation service provider (ANSP), or other organizational entity that manages ATN/IPS network resources and services) – and consists of IPS nodes (i.e., IPS routers and IPS hosts).

The ATN/IPS network must accommodate existing and future air-ground access networks, including but not limited to:

- VDLM2
- Safety Satcom (e.g., INMARSAT SB-Safety, Iridium Certus)
- L-band Digital Aeronautical Communications System (LDACS)
- Aeronautical Mobile Airport Communication System (AeroMACS)
- HF Next (HFN)

As a part of the layered IPS security approach, each air-ground access network must be secured. Authentication for IPS service must be supported across all air-ground links. Authentication is performed between the Airborne IPS System and the communicating peer Ground IPS Node (i.e., IPS Gateway or Ground IPS Host), the placement of which is dependent on the deployment option, which may be at the ACSP for the particular access network.

3.0 IPS GATEWAY FUNCTION

3.0 IPS GATEWAY FUNCTION

3.1 Transition-driven Considerations

When considering safety services applications, it is important to provide a means for transparent communication between IPS-enabled systems and those systems that still use legacy ACARS or OSI network technologies.

The IPS Gateway architecture must take into consideration that ground systems (i.e., ATC centers and airline AOC) will have different configurations (leftmost column in Table 3-1), which will depend on regional datalink communication differences. For example, Europe does not plan to implement FANS-1/A in domestic airspace, and the US does not plan to implement B1 or OSI in domestic airspace. In Table 3-1, the intersecting cells summarize the interoperability between the ground system configurations and various aircraft configurations; note that a given aircraft may implement multiple stacks (e.g., ACARS and OSI, ACARS and IPS) and a given ground system may implement multiple stacks (e.g., FANS-1/A ACARS and B1/B2 OSI). The blue-shaded “GW” cells identify where an IPS Gateway is necessary for an IPS-equipped aircraft to interoperate with non-IPS-enabled ground centers or for non-IPS aircraft to interoperate with IPS-enabled ground systems.

COMMENTARY

Per the assumptions in ARINC 858 Part 1 Section 2.5, a triple-stack aircraft is not envisioned although not precluded. Similarly, a triple-stack ground center is not envisioned, although it is not precluded.

Table 3-1 – Ground Configuration versus Aircraft Configuration

Ground Configuration (application and stack)	Aircraft Configuration (application and stack)					
	Any ACARS	AOC IPS	ARINC 623 IPS	FANS-1/A IPS	B1/B2 IPS	B1/B2 OSI
AOC ACARS	YES	GW				
AOC IPS	GW	YES				
ARINC 623 ACARS	YES		GW			
FANS-1/A ACARS	YES			GW		
B1/B2 OSI					GW	YES
B1/B2 IPS					YES	GW

Legend:
 YES = Interoperability supported currently or without the need for an IPS Gateway
 GW = Interoperability supported with an IPS Gateway
 <blank> = Interoperability not supported (see commentary)

It should be emphasized that the IPS Gateways described in this document are intended to act as a bridge for messages of the same application type but using different network technologies. For example, an IPS Gateway will convey FANS-1/A messages from ACARS to IPS; however, mapping of FANS-1/A applications to B1/B2 applications is outside the scope of this document.

COMMENTARY

Note that compatibility among applications (e.g., similar message sets, common message elements, etc.) is separate from network protocol compatibility. Application accommodation guidance is given in documents such as RTCA DO-352A/EUROCAE ED-231A, and it is

3.0 IPS GATEWAY FUNCTION

up to the ANSPs to determine whether accommodation between different applications can still achieve the desired operational benefit, or whether the lack of some features means that aircraft cannot receive data link services.

3.2 Primary Use Cases

The transition considerations described in the previous section drive two main use cases that must be supported by the IPS Gateways:

- IPS-enabled aircraft communicating with legacy ground systems (i.e., ACARS Host or OSI End System).
- Legacy aircraft communicating with Ground IPS Hosts.

These two use cases are shown in Figure 3-1 and Figure 3-2, respectively. While the IPS/OSI Gateway and IPS/ACARS Gateway are shown separately, an implementation may combine those gateway functions into a single system or service. In addition, the IPS Gateways are shown between network clouds to highlight the gateway functionality; however, depending on the deployment scenario, an IPS Gateway may be an integral component of one cloud or another.

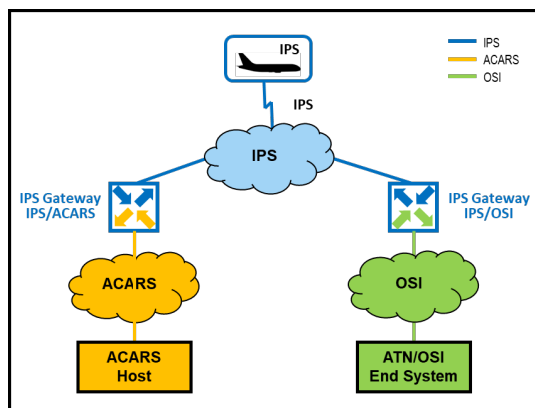

Figure 3-1 – IPS Aircraft Communicating with Legacy Ground Systems via an IPS Gateway

3.0 IPS GATEWAY FUNCTION

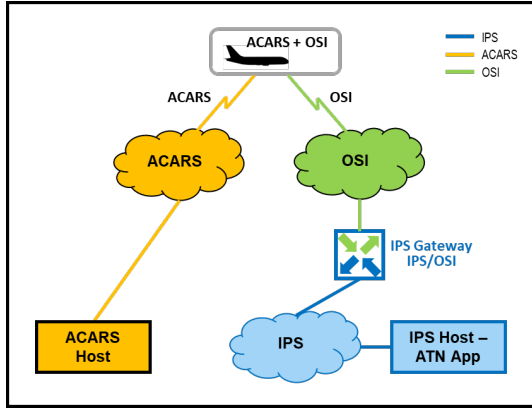

Figure 3-2 – Legacy Aircraft Communicating with a Ground IPS Host via an IPS Gateway

Note that existing ACARS Hosts are expected to continue to support legacy ACARS interfaces. Therefore, a legacy aircraft communicates directly with an ACARS Host as it does today (as shown in Figure 3-2), and an IPS-enabled aircraft communicates with an ACARS Host via an IPS Gateway (as shown in Figure 3-1).

3.3 Functional Description

The IPS Gateway provides operational associations (i.e., maintaining protocol relationships and required state information) and protocol conversions between application hosts located in the IPS network and application hosts located in legacy ACARS and OSI networks. The IPS Gateway function supports ACARS-based ATS and AOC applications, ATN/OSI-based ATS applications, and ATN/IPS-based ATS and AOC applications. A high-level functional diagram is shown in Figure 3-3.

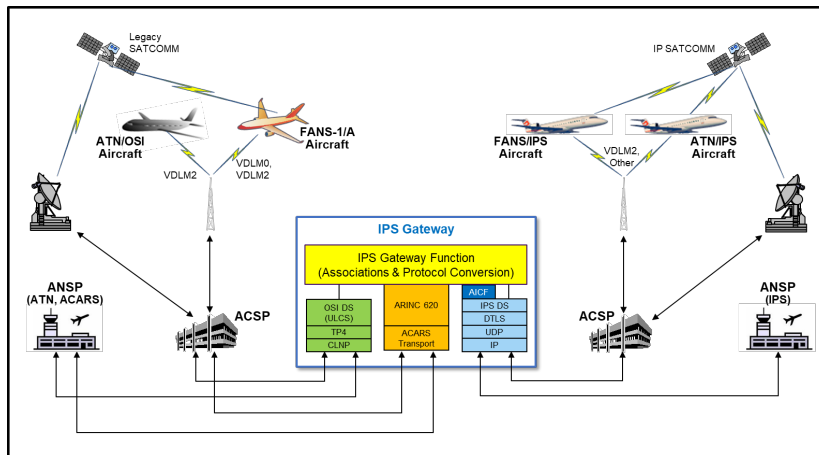

Figure 3-3 – IPS Gateway High-Level Functional Overview

3.0 IPS GATEWAY FUNCTION

COMMENTARY

The diagram illustrates a notional functional architecture that facilitates the description of the IPS Gateway Function in this document. However, an IPS Gateway may be implemented using an alternate functional allocation that achieves the same interoperability. In addition, as described in Section 3.4.5, additional services that support the management and operation of the IPS network may be co-located with an IPS Gateway.

In this diagram, ACARS or ATN/OSI equipped aircraft can communicate with Air-Ground Communication Service Providers (ACSPs) that establish a connection with the IPS Gateway using the relevant communications protocol.

From the point of view of a native IPS Host, communication via an IPS Gateway is no different than communication directly with any other native IPS Host. That is, the IPS Gateway acts as an application-level transparent proxy.

Similarly, the legacy application hosts should not need any special provisions to reach their correspondent hosts located in the IPS network. The IPS Gateway establishes an association using information about both endpoint systems, and the interactions are transparent in both directions from the end-to-end application point-of-view, i.e., applications communicate as they would in their native domain and are unaware that there is an IPS Gateway.

Achieving this level of network transparency requires that the IPS Gateways not only be able to forward the application messages, but also distribute the reachability information in the corresponding networks. This means that the networks in each domain served by the IPS Gateway must know how to forward the packets between the IPS Gateway and the hosts in the respective domains.

3.4 IPS Gateway Functional Requirements

3.4.1 Operational Associations

A clear association must be made between the end systems on an aircraft and the end system on the ground. This association is performed today for ATC messaging and is critically important since it ensures that the aircraft and the ground know unambiguously that messages are delivered to the intended recipients. The association may be done using different operational data (e.g., flight plans, 24-bit addresses, facility designations, etc.) and technical means (e.g., connection statuses, state information, etc.). Care must be taken to account for normal disruptions such as equipment changes, flight cancellations or modifications, etc.

As shown in Figure 3-4, there are three associations required when using an IPS Gateway:

- Association between the aircraft and the gateway,
- Association between the gateway and ground system, and
- Association between the aircraft and the ground system.

These relationships are called associations and not translations since they are based on discrete end-to-end connections between the IPS Gateway and the end systems. Data between the different technologies is used in establishing connections. The IPS Gateway uses the data exchanged via each of the networking technologies to establish the association between the aircraft and ground systems.

3.0 IPS GATEWAY FUNCTION

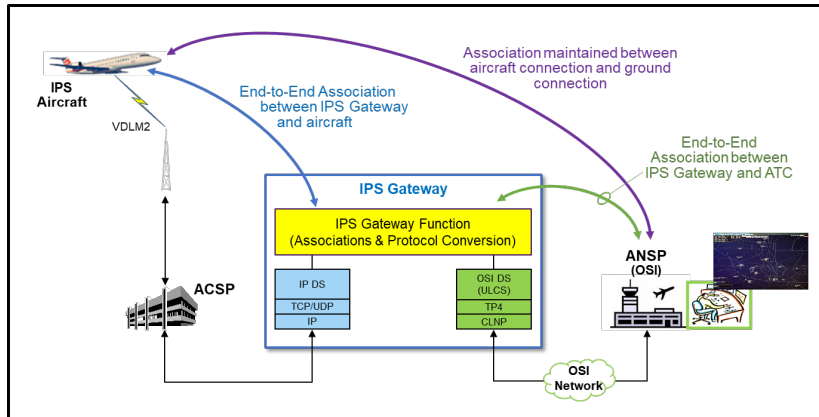

Figure 3-4 – IPS Gateway Associations – IPS to OSI Example

Figure 3-4 illustrates an IPS Aircraft communicating with an OSI ground end system; however, the associations are similar for an IPS Aircraft communicating with a Ground ACARS Host or for an OSI Aircraft communicating with a Ground IPS Host. The IPS Gateway supports at least one IPS-to-OSI association or IPS-to-ACARS association. Depending on the operational needs, both types of protocol associations may be supported by a single IPS Gateway.

The IPS Gateway maintains the three associations (as shown in Figure 3-4) between an aircraft to end system connection for the duration of the application-level connection (e.g., a CPDLC session). The IPS Gateway association function uses the aircraft's 24-bit address, tail number, flight identifier, ground facility designation, application addresses, and connection information (e.g., called and calling peer ID) to establish and maintain the associations. Additional information, such as departure and destination airports, may also be used if available to the IPS Gateway.

Since the IPS Gateway's purpose is to perform the technical associations from a connection standpoint, the IPS Gateway does not have to perform operational checks such as filed flight plan lookups. While additional functionality can be added to perform actions such as checking the aircraft information against filed flight plans, those checks are generally performed by the destination end system and not the IPS Gateway.

3.4.2 State Mapping

The IPS Gateway maintains state information necessary for the air and ground end systems to communicate. This means that the IPS Gateway becomes a termination point in the communication chain. By maintaining an association between the connections and end systems and keeping state information synchronized, the IPS Gateway functionality is transparent to the end users. The IPS Gateway maintains state information for the aircraft and ground system applications and applies rules to ensure that the state information is kept consistent, to react correctly to received events, and to generate necessary events. There may be cases where exact protocols are not matched (e.g., for some provider abort situations), but the end result will be the same operationally.

3.0 IPS GATEWAY FUNCTION

Additionally, since the IPS Gateway serves as a connection and end-system mid-point, separate peer end system mappings are required. This is because the IPS Gateway peer function needs to emulate an aircraft end system for some message exchanges and a ground end system for others. These cases are detailed in Section 4.0, IPS Gateway for ACARS, and Section 5.0, IPS Gateway for OSI.

3.4.3 Protocol Conversion

The IPS Gateway provides protocol conversion between an IPS-enabled entity and a legacy entity, either an ACARS Host or an OSI End System. The IPS-facing side of the IPS Gateway implements the IPS Dialogue Service (DS), which is necessary for all protocol conversions, and the ACARS to IPS DS Convergence Function (AICF), which is necessary only for ACARS-based applications.

The following bullets summarize the protocol conversion requirements that are applicable to both IPS-ACARS and IPS-OSI Gateways:

- Provide a termination point for the IPS network and its transport layers
- Maintain key aircraft information (e.g., tail number, flight id)
- Maintain a Session Record for the specific “connection,” defined by:
 - Source Port and Destination Port pair
 - Source IP Address and Destination IP Address pair
- Provide security context management for each IPS secure dialogue
- Provide IPS DS adaptation per ICAO Doc. 9896, which defines the ATN Packet (ATNPKT) format and protocol

For message exchanges between an IPS Aircraft and ACARS Host, the IPS Gateway:

- Provides message compression/decompression, which is performed by the AICF as described in ARINC 858 Part 1, Attachment 3
- Generates an ACARS message from an ATNPKT and forwards the message to the ACARS Host
- Conversely, generates an ATNPKT from an ACARS message and forwards the message to the IPS Aircraft
- Provides ACARS Message Assurance (MAS) messages to the ACARS Host, if requested
- Handles ACARS supplemental address forwarding. If ACARS-based messages contain optional supplemental addresses, then the IPS Gateway is responsible for forwarding copies of downlink messages to the addressed ground entities. This function is performed normally by an ACARS service provider; however, if the IPS Gateway is deployed at an end system, such as an ANSP, then the end system must perform this forwarding function.

For message exchanges between an IPS Host and ATN/OSI End System, the IPS Gateway:

- Provides a termination point for the Connectionless Network Protocol (CLNP) and Connection-Oriented Transport Protocol (COTP) connection with the ATN/OSI End System
- Manages the CLNP/COTP connection with the ATN/OSI End System

3.0 IPS GATEWAY FUNCTION

- Generates an ATN/OSI message from an ATNPKT and forwards the message to the ATN/OSI End System
- Conversely, generates an ATNPKT from an ATN/OSI message and forwards to the IPS Host

3.4.4 Security

Since IPS includes application-level security between communicating peer IPS entities, the IPS Gateway must act as a security end-point that terminates the IPS application-level security sessions. All security requirements that are applicable to a native Ground IPS Host are also applicable to the IPS Gateway.

Although the legacy ACARS and OSI networks do not implement end-to-end application-level security, they do provide existing security solutions such as ground-ground security. Those existing security solutions are not discussed in this document.

When IPS is deployed, additional ground interface security controls may be necessary for an IPS Gateway to meet local security policy (e.g., security requirements for an ACSP-operated IPS Gateway to connect to an ANSP). Local policy-driven requirements for ground-ground security are in addition to IPS end-end application-level security and must not impact interoperability of the Airborne IPS System with the IPS Gateway, from either end-end performance or end-to-end security perspectives.

3.4.5 Additional Support Services

Implementations of IPS Gateways may provide additional services that are vital for operation of the IPS network, such as Simple Name Lookup Service or the IPS Management Application services defined in ICAO Doc. 9896. Since the primary focus of this document is the IPS Gateway Function, the scope of this document does not include a description of how these support services may be integrated with the IPS Gateway.

3.5 Deployment Considerations

IPS Gateways are ground entities that can be deployed in any part of the ground IPS network segment that is interconnected with the legacy networks. While the diagrams in this document locate the IPS Gateway centrally to emphasize the gateway functionality and message flows, the IPS Gateway can be placed in any ground administrative domain, and it could be associated with an Air-Ground Communications Service Provider (ACSP), with a specific ANSP, or with a specific airline, as shown previously in Figure 1-1. The choice of a particular deployment option depends on many factors, such as State regulations, regional operations, business case, etc. Deployment options are discussed in ARINC 858 Part 1, Section 2.4, and additional IPS deployment scenario considerations are provided in the IPS MASPS (RTCA DO-XXX and EUROCAE ED-YYY).

It is assumed that deployment of the IPS network will include multiple instances of IPS Gateways. The number of IPS Gateways may also increase over time as the deployment of IPS technology becomes more widespread.

Multiple instances of IPS Gateways are especially important in light of the IPS multilink approach. The state of air-ground access networks and the underlying ACSPs can change during the aircraft flight phases or due to performance reasons. An application session between an IPS Aircraft and a legacy host via the IPS

Commented [OML6]: [P2-M17-01 – G.Saccone] - Revisit whether there are any G-G security impacts on IPS GW

Commented [OML7R6]: Incorporated text discussed during Dec telecon.

3.0 IPS GATEWAY FUNCTION

Gateway should be maintained regardless of the air-ground access network or the underlying ACSPs.

The scenario above implies two requirements:

- Once an application session is started via a particular instance of the IPS Gateway, the underlying network always delivers the session's traffic to that IPS Gateway regardless of the aircraft's point of attachment to the network.
- Depending on deployment options chosen, there may be an IPS Gateway synchronization mechanism that allows multiple IPS Gateways to exchange the application session state with one another. With such a mechanism in place, any instance of the IPS Gateway can forward the application messages correctly. This approach is not discussed in this document.

3.6 Performance and Safety Considerations

IPS Gateway performance is driven by performance requirements (e.g., availability, transaction time, integrity, etc.) that are allocated to the Ground IPS System, as specified in the IPS MASPS (RTCA DO-XXX and EUROCAE ED-YYY).

4.0 IPS GATEWAY FOR ACARS

4.0 IPS GATEWAY FOR ACARS

4.1 Principle of Operation

The IPS Gateway is responsible for converting IPS messages carrying data that transits the ACARS network (e.g., FANS 1/A, ATS, and AOC data) into ACARS messages, and vice versa, by performing the following generalized actions:

- Receive a packet originating from an airborne or ground ACARS Host
- Inspect the packet header and extract the relevant fields
- Perform segmentation or reassembly as necessary
- Create the message in the form appropriate for the destination
- Identify/select the path to the destination
- Send the message to the destination.

The IPS Gateway serves as the peer to the IPS Aircraft for these legacy applications. It runs instances of IPS Dialogue Service (IPS DS) and ACARS to IPS Dialogue Service Convergence Function (AICF, per ARINC 858 Part 1, Attachment 3) that act as the termination points for the equivalent components used by IPS Aircraft. As shown in Figure 4-1, the messages exchanged between the IPS Gateway and the IPS Aircraft are converted to/from ARINC 620 ACARS messages. The IPS Gateway is responsible for extracting the parameters and application data from ATNPKT and assembling the ACARS message in ARINC 620 format.

The IPS Gateway is also responsible for providing the Message Assurance (MAS) and intercepts functionality back to legacy ACARS systems.

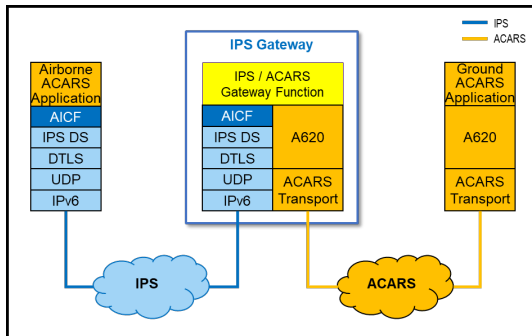

Figure 4-1 – IPS Aircraft Communicating with an ACARS Host via an IPS Gateway

COMMENTARY

The ACARS Ground Network may use various protocols to transport messages. One example is MATIP, Mapping of Airline Traffic over Internet Protocol. The choice of protocols is typically implementation or service provider specific. Those protocols are represented in the figure by the “ACARS Transport” protocol blocks.

IPS Gateways that support IPS-to-ACARS gateway function must support the conversion between the following ACARS protocols:

- FANS-1/A AICF/IPS and ARINC 622/620 ACARS

Commented [OML8]: [P2-M19-01 – G.Saccone] - Add guidance/examples for how the IPv6 address is resolved for ACARS Hosts. (Point to high level guidance on name lookup in Doc. 9896, then add any additional ACARS-specific guidance in 858P2.)

Commented [OML9R8]: M21 – Decision to move proposed text to Part 1 and add a pointer in a new Section 4.2 – see below.

4.0 IPS GATEWAY FOR ACARS

- ARINC 623 AICF/IPS and ARINC 623/620 ACARS
- AOC AICF/IPS and ARINC 620 ACARS

As highlighted in Section 3.2, the IPS Gateway is not required to provide the conversion of ARINC 618 protocol message to AICF interface. The use case of communication between a legacy ACARS aircraft and Ground IPS ACARS Host is not envisaged.

4.2 Ground Address Acquisition

The Airborne IPS System acquires the IPv6 address of the Ground ACARS Host using either pre-configured on-aircraft IPv6 address storage, as described in ARINC 858 Part 1, Section 3.5.1.4) or ground-based Simple Name Lookup Service (SNL) as described in ARINC 858 part 1, Section 3.6.1, and specified in ICAO Doc. 9896.

Commented [OML10]: Addresses [P2-M19-01 – G.Saccone]

4.2.4.3 Mapping of ARINC 620 Messages to the AICF Interface

4.2.4.3.1 Downlink Message Conversion

An IPS/ACARS Gateway converts downlink messages received via the IPS DS and AICF into ARINC 620 ground-ground messages by applying the IPS Gateway processing described in Table 4-1. At the IPS Gateway, the IPS DS performs ATNPKT reassembly, as required, and acknowledges received downlinks. The AICF performs message decompression and message conversion, i.e., generating an ARINC 620 message from the downlink ATNPKT. The generated ARINC 620 messages are then injected into ACARS ground network and delivered to the destination Ground ACARS Host.

Table 4-1 – Downlink Message Conversion and Mapping Process

Input Parameters from IPS DS ATNPKT	IPS Gateway Processing (Notes 1 and 2)	Ground-Ground Output Parameters
Called Peer ID Parameter (Note 1)	Map Center Name to the Destination Address	7-character destination address
Supplemental Addresses (contained in the User Data field)	Parse up to 16 downlink Destination Addresses, each of which is separated by a space character	7-character destination address for each additional destination, to which a copy of the message is sent
Label / Sub-label (contained in the User Data field)	Map to Standard Message Identifier (SMI)	SMI
Calling Peer ID parameter	Map the FlightID to the Flight Identifier (FI) Text Element Identifier 1 (TEI_1)	FI TEI (a maximum length of 7 characters)
User Data	Parse TEIs (if included) Note that the IPS Gateway may create the Aircraft Tail Number (AN) TEI using information contained in the User Data or using additional information, such as IPv6 address or network logon information (if available)	TEI list
User Data	Parse free text containing application message	Free text

4.0 IPS GATEWAY FOR ACARS

Input Parameters from IPS DS ATNPKT	IPS Gateway Processing (Notes 1 and 2)	Ground-Ground Output Parameters
<p>Note 1: This example shows the mapping for FANS-1/A messages; a similar conversion is performed for other ACARS-based applications. As specified in ARINC 858 Part 1, Attachment 3, note that the Called Peer ID is not included in downlink AOC messages.</p> <p>Note 2: Not all mapping is shown, and the reader is referred to ARINC 620 for the detailed specification of ground-ground ACARS messages.</p>		

If ACARS-based messages contain optional supplemental addresses, then the IPS Gateway is responsible for forwarding copies of the downlink messages to the addressed ground entities. If the IPS Gateway is endpoint hosted (e.g., by an ANSP), then the endpoint system must perform this forwarding function, which is performed normally by an ACARS Datalink Service Provider (DSP).

The example in Figure 4-2 shows how the data contained in an ATNPKT is converted to an ARINC 620 message. In this example, the downlink message is an ATS Facilities Notification (AFN) connection request (FN_CON) message sent from an IPS Aircraft with FlightID "AB1234" to Shanwick ATC center "PIKCPYA". The user data field in the ATNPKT includes the application message, which is shown compressed using DEFLATE compression, and alternatively, also shown with no compression.

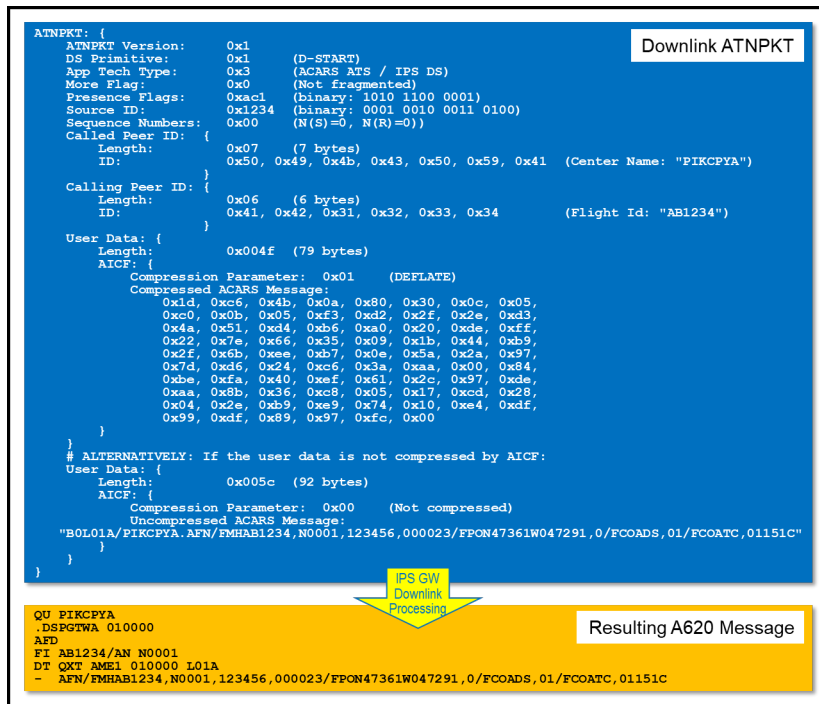

Figure 4-2 – ARINC 620 Downlink Message Conversion Example

Commented [OML11]: [P2-M22-01 – M.olive / F. Wrobel] - Update Conversion Example figures to reflect changes to the ATNPKT fixed field to accommodate port simplification. (Interdependency with ICAO WG-1.)

4.0 IPS GATEWAY FOR ACARS

4.2.24.3.2 Uplink Message Conversion

Uplink messages that are received via the ground ACARS network are converted to AICF interface calls and formatted in an IPS DS ATNPKT by applying the IPS Gateway processing described in Table 4-2. At the IPS Gateway, AICF performs message compression, and the IPS DS performs ATNPKT segmentation, as required, and generates the uplink ATNPKT.

Table 4-2 – Uplink Message Conversion and Mapping Process

Ground-Ground ARINC 620 Input Parameters	IPS Gateway Processing (Note 1 and 2)	IPS DS ATNPKT Parameters
Aircraft Tail Number (AN) Text Element Identifier (TEI)	Determine the FlightID from the aircraft registration number	Called Peer ID parameter containing FlightID
ARINC 620 Signature (containing Center Address)	Map Center Address to the Center Name	Calling Peer ID containing Center Name (Note 1)
SMI	Determine the IPS DS Technology Type based on the SMI	Set Technology Type field
SMI	Map SMI to Label / Sub-label	Part of the User Data
<-><sp><sp>FreeText where <-> is a dash character and <sp> is a space character	Parse FreeText	Part of the User Data
Note 1: This example shows the mapping for FANS-1/A messages. A similar conversion is performed for other ACARS-based applications; in the case of AOC applications, note that Calling Peer ID is not included in uplink messages as specified in ARINC 858 Part 1, Attachment 3.		
Note 2: Not all mapping is shown, and the reader is referred to ARINC 620 for the detailed specification of ground-ground ACARS messages.		

The IPS Gateway generates a Message Assurance (MAS) message for each received ARINC 620 message that contains an MA TEI. **If an uplink cannot be delivered and MAS was not requested, the IPS Gateway is responsible for generating a service message (SVC) with the intercept information that is returned to the sender.** In addition, when the Transmission Path (TP) TEI is included, the IPS Gateway forwards the message to the appropriate air-ground access network based on the TP parameter value specified by the Ground ACARS Host.

The example in Figure 4-3 shows how the data contained in an ARINC 620 uplink message is converted to an ATNPKT. In this example, the uplink message is an AFN connection acknowledgement (FN_AK) message sent from Shanwick ATC center "PIKCPYA" to an IPS Aircraft with FlightID "AB1234". The user data field in the ATNPKT includes the application message, which is shown compressed using DEFLATE compression, and alternatively, also shown with no compression.

Commented [OML12]: p/o changes to address P2-M19-02

4.0 IPS GATEWAY FOR ACARS

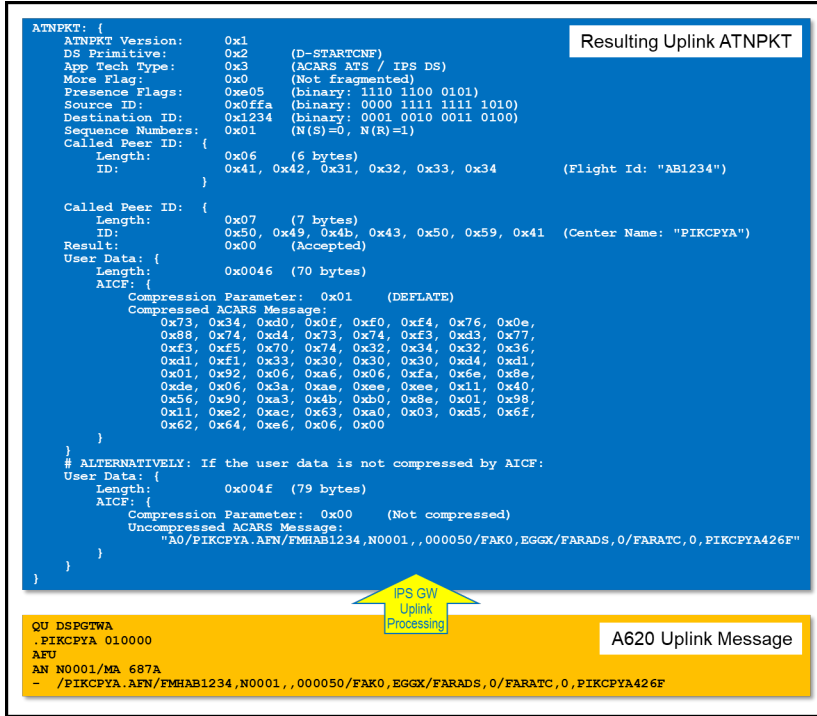

Figure 4-3 – ARINC 620 Uplink Message Conversion Example

Commented [OML13]: [P2-M22-01 – M.olive / F. Wrobel] - Update Conversion Example figures to reflect changes to the ATNPkt fixed field to accommodate port simplification. (Interdependency with ICAO WG-1.)

4.34.4 State Tables

The tables and associated diagrams in this section describe the state mapping for the air-initiated and ground-initiated ACARS applications. In all cases, the IPS Gateway requires knowledge of the aircraft tail number and aircraft architecture type to support translation of ACARS messages. This can be accomplished via a database that associates the IPv6 address with the aircraft 24-bit address or other means for obtaining the information (e.g., address lookup service). In addition, to support correct ARINC 620 formatting, it may also be convenient for the IPS Gateway to know the association between ICAO and International Air Transport Association (IATA) airline codes and a specific aircraft tail number.

The illustrative diagrams in this section use the following notation:

- IPS message flow: **UDP port number: DS-PRIMITIVE [application payload type: application message type]**, which represents an ATNPkt that is exchanged over a Datagram Transport Layer Security (DTLS)-secured session and where the application payload may be compressed by the AICF. The application-specific User Datagram Protocol (UDP) port number assignments are specified in ICAO Doc. 9896.
- ACARS message flow: **A620 [application payload type: application message type]**

4.0 IPS GATEWAY FOR ACARS

As noted previously in Section 4.1, the IPS Gateway is responsible for providing Message Assurance (MAS) if this optional service is requested by the Ground ACARS Host, and for providing undeliverable uplink service messages when MAS is not requested. For simplicity, MAS and delivery failure notifications are not included in the tables in this section since they do not impact the state mapping; however, MAS is shown in the detailed message exchange examples in Section 4.5.

Commented [OML14]: p/o changes to address P2-M19-02

4.3.14.4.1 Air-Initiated Applications

For an IPS Aircraft communicating with an ACARS Ground Host, the state mapping for the air-initiated AFN connection service is provided in Table 4-3 and shown in Figure 4-4 and Figure 4-5.

Table 4-3 – IPS to ACARS State Mapping – AFN Logon

IPS		ACARS
AFN – Ground Processing / State	IPS GW Protocol and Association Processing	AFN – Aircraft Processing / State
→	→	→
Per ARINC 858 Part 1, Attachment 3, Section 3.2 for receipt of D-START	Receive D-START from GW AFN-Ground IPS entity Perform operational association between aircraft and ground end system as described in Section 3.4.1 Obtain the aircraft tail number and aircraft architecture type based on the operational association process Create FN_CON ARINC 622 data using the tail number and information extracted from the D-START, including: FlightID, Label, MSN, Sub-label (optional), Supplementary Address(es) (optional), and Message text Pass FN_CON data to IPS GW AFN-Aircraft ACARS entity	Send FN_CON as per ARINC 622 and ARINC 620
←	←	←
Per ARINC 858 Part 1, Attachment 3, Section 3.3 create D-STARTCNF ATNPKT	Receive FN_AK from GW AFN-Ground ACARS entity Perform operational association between aircraft and ground end system as described in Section 3.4.1 Obtain the aircraft tail number and aircraft architecture type based on the operational association process Create the D-STARTCNF data using the tail number and information extracted from the FN_AK, including: Label, Sub-label (optional), Supplementary Address(es) (optional), and Message text Pass the D-STARTCNF parameters to IPS GW CPDLC-Ground ACARS entity	Per ARINC 622 and ARINC 620 for receipt of an FN_AK

4.0 IPS GATEWAY FOR ACARS

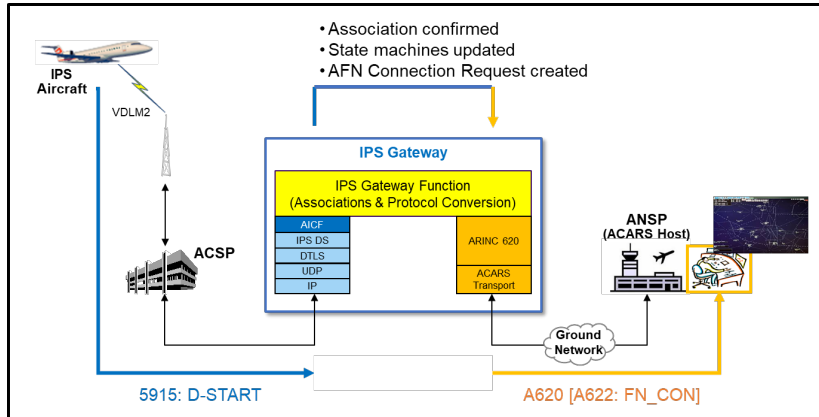

Figure 4-4 – FANS-1/A AFN Connection Request Downlink

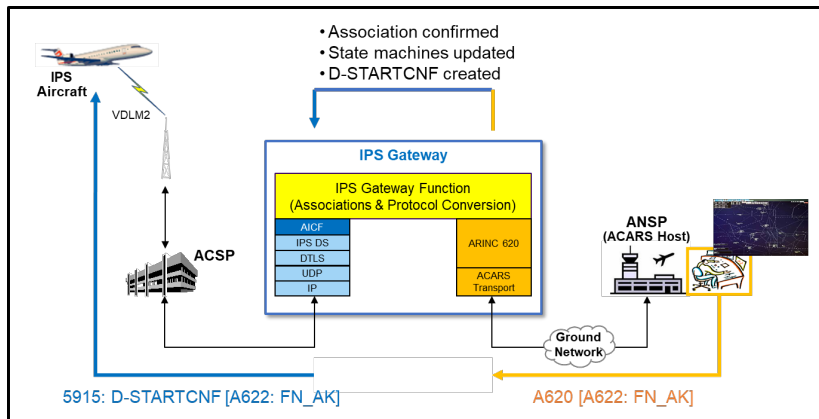

Figure 4-5 – FANS-1/A AFN Uplink Acknowledgement Response

4.3.24.4.2 Ground-Initiated Applications

For an IPS Aircraft communicating with an ACARS Ground Host, the state mapping for the ground-initiated AFN contact advisory service is provided in Table 4-4 and shown in Figure 4-6, Figure 4-7, and Figure 4-8.

4.0 IPS GATEWAY FOR ACARS

Table 4-4 – IPS to ACARS State Mapping – AFN Contact Advisory

IPS		ACARS
AFN – Ground Processing / State	IPS GW Protocol and Association Processing	AFN – Aircraft Processing / State
←	←	←
<p>Per ARINC 858 Part 1, Attachment 3, Section 3.3 create D-DATA ATNPKT</p>	<p>Receive FN_CAD from GW AFN-Aircraft IPS entity</p> <p>Perform operational association between aircraft and ground end system as described in Section 3.4.1</p> <p>Obtain the aircraft tail number and aircraft architecture type based on the operational association process</p> <p>Create the necessary D-DATA parameters including the tail number and additional information extracted from the FN_CAD including: FlightID, Label, Sub-label (optional), Supplementary Address(es) (optional), and Message text</p> <p>Pass D-DATA parameters to IPS GW AFN-Ground ACARS entity</p>	<p>Receipt of FN_CAD as per ARINC 622 and ARINC 620</p>
→	→	→
<p>Per Doc. 9896 for receipt of D-ACK for D-DATA</p>	<p>Receive D-ACK from GW AFN-Ground ACARS entity</p> <p>Perform operational association between aircraft and ground end system as described in Section 3.4.1</p> <p>Obtain the aircraft tail number and aircraft architecture type based on the operational association process</p> <p>Create FN_RESP data using the tail number and additional information for the aircraft including: FlightID, Label, Sub-label (optional), Supplementary Address(es) (optional), and Message text</p> <p>Pass FN_RESP data to IPS GW AFN-Aircraft ACARS entity</p>	<p>Send FN_RESP as per ARINC 622 and ARINC 620 [Note 1]</p>

4.0 IPS GATEWAY FOR ACARS

IPS		ACARS
AFN – Ground Processing / State	IPS GW Protocol and Association Processing	AFN – Aircraft Processing / State
<p>→</p> <p>Per ARINC 858 Part 1, Attachment 3, Section 3.2 for receipt of D-DATA</p>	<p>→</p> <p>Receive D-DATA from GW AFN-Ground ACARS entity</p> <p>Perform operational association between aircraft and ground end system as described in Section 3.4.1</p> <p>Obtain the aircraft tail number and aircraft architecture type based on the operational association process</p> <p>Create FN_COMP data using the tail number and information extracted from the D-DATA including: FlightID, Label, MSN, Sub-label (optional), Supplementary Address(es) (optional), and Message text</p> <p>Pass FN_COMP data to IPS GW AFN-Aircraft ACARS entity</p>	<p>→</p> <p>Send FN_COMP as per ARINC 622 and ARINC 620</p>
<p>Note 1: The IPS GW sends an FN_RESP to the ACARS Host that originated the FN_CAD. This should be done upon receipt of the D-ACK indicating that the aircraft has received the FN_CAD. Since some information may not be available in the D-ACK itself (e.g., MSN), that information must be obtained from the current association data.</p>		

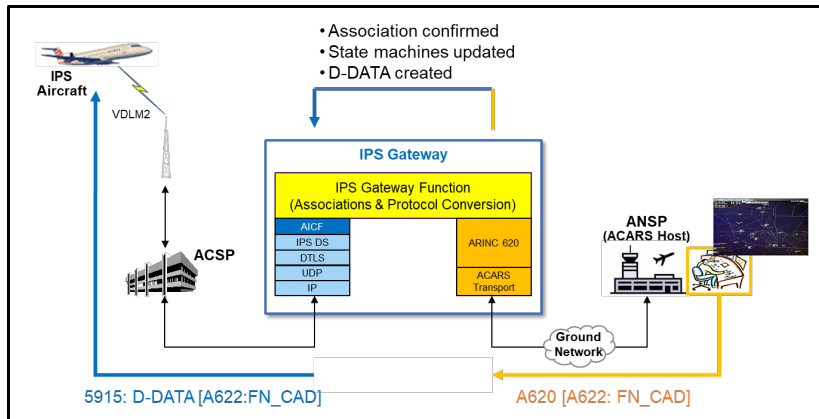

Figure 4-6 – FANS-1/A AFN Contact Advisory Uplink Request

4.0 IPS GATEWAY FOR ACARS

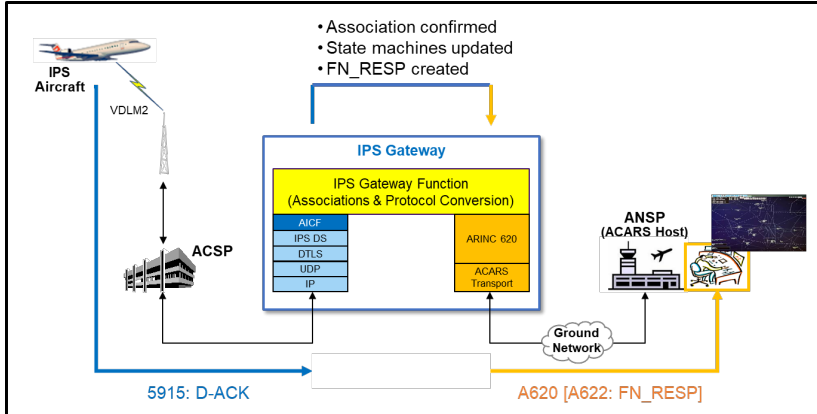

Figure 4-7 – FANS-1/A AFN Contact Advisory Downlink Response

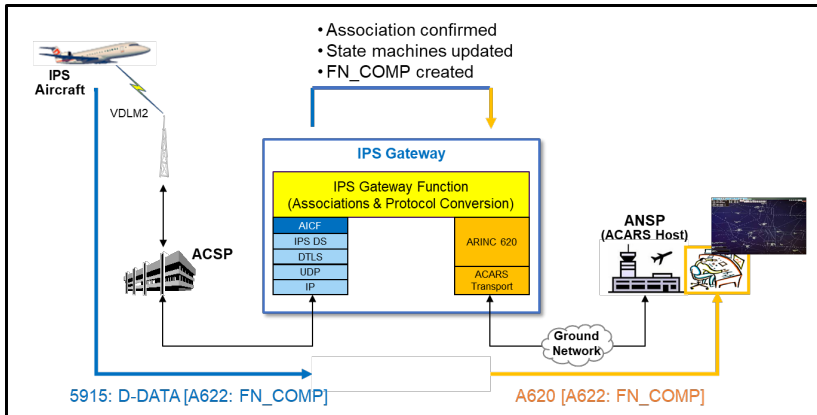

Figure 4-8 – FANS-1/A AFN Contact Advisory Complete Downlink

For an IPS Aircraft communicating with an ACARS Ground Host, the state mapping for the ground-initiated CPDLC or ADS-C application service (when there is not an existing dialogue) is provided in Table 4-5 and shown in Figure 4-9 and Figure 4-10.

4.0 IPS GATEWAY FOR ACARS

Table 4-5 – IPS to ACARS State Mapping – CPDLC or ADS-C (No Existing Dialogue)

IPS		ACARS
CPDLC or ADS-C – Ground Processing / State	IPS GW Protocol and Association Processing	CPDLC or ADS-C – Aircraft Processing / State
←	←	←
<p>Per ARINC 858 Part 1, Attachment 3, Section 3.3 create D-START ATNPKT</p>	<p>Receive CR1 from GW CPDLC-Aircraft IPS entity or ADS from GW ADS-C-Aircraft IPS entity</p> <p>Perform operational association between aircraft and ground end system as described in Section 3.4.1</p> <p>Obtain the aircraft tail number and aircraft architecture type based on the operational association process</p> <p>Create the necessary D-START parameters including the tail number and additional information extracted from the CR1 or ADS message, including: FlightID, Center Name, Label, Sub-label (optional), Supplementary Address(es) (optional), and Message text.</p> <p>Pass D-START parameters to IPS GW CPDLC-Ground ACARS entity or ADS-C-Ground ACARS entity</p>	<p>Receipt of CR1 or ADS as per ARINC 622 and ARINC 620 [Note 1]</p>
→	→	→
<p>Per ARINC 858 Part 1, Attachment 3, Section 3.2 for receipt of D-STARTCNF</p>	<p>Receive D-STARTCNF from GW CPDLC-Ground ACARS entity</p> <p>Perform operational association between aircraft and ground end system as described in Section 3.4.1</p> <p>Obtain the aircraft tail number and aircraft architecture type based on the operational association process</p> <p>Create CC1 or ADS data using the tail number and information extracted from the D-STARTCNF, including: FlightID, Center Name, Label, MSN, Sub-label (optional), Supplementary Address(es) (optional), and Message text</p> <p>Pass CR1 data to IPS GW CPDLC-Aircraft ACARS entity or ADS data to IPS GW ADS-C-Aircraft ACARS entity</p>	<p>Send CC1 or ADS as per ARINC 622 and ARINC 620</p>
<p>Note 1: The specific types of ADS messages will be contained within the message text of the messages themselves. This can include different types of contract requests in the uplink direction and acknowledgements and reports in the downlink direction.</p>		

4.0 IPS GATEWAY FOR ACARS

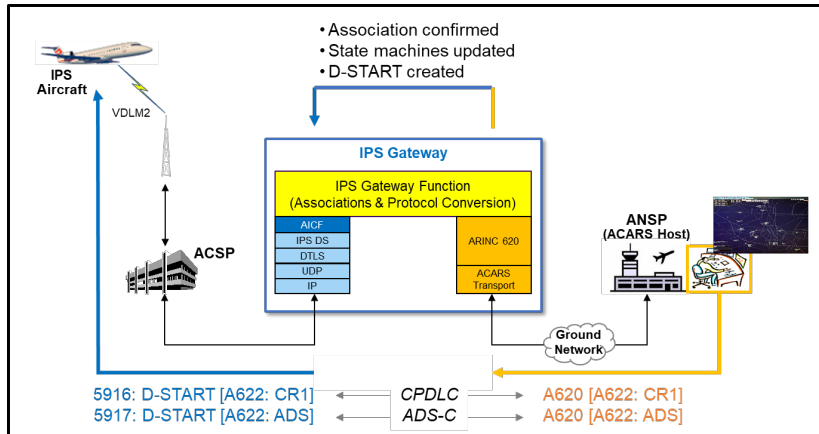

Figure 4-9 – FANS-1/A CPDLC or ADS-C Uplink (No Existing Dialogue)

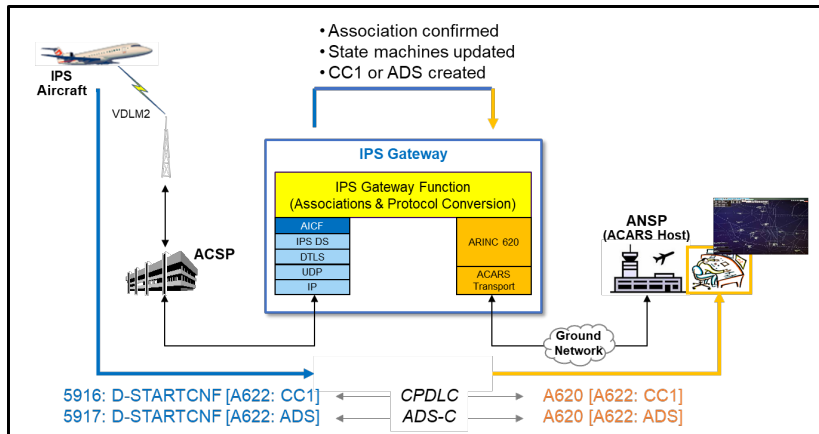

Figure 4-10 – FANS-1/A CPDLC or ADS-C Downlink (No Existing Dialogue)

For ground-initiated ACARS applications where there is an existing dialogue (i.e., the application-specific dialogue status is set to “OPEN” for the entity initiating a request), the previous state tables and associated diagrams are applicable; however, the IPS DS primitive that is used to exchange the messages may be different. Refer to the application-specific primitive mapping tables in ARINC 858 Part 1, Attachment 3, Section 3.4.

4.4.4.5 Message Exchange Examples

The following subsections present examples of the communication between an IPS Aircraft and an ACARS Host via an IPS/ACARS Gateway. The sequence diagrams show the messages that are exchanged over the IPS and ACARS networks using the message flow notation defined in Section 4.3.

4.0 IPS GATEWAY FOR ACARS

The following are assumed in each of the examples:

- “IPS Aircraft” represents the Airborne IPS System per ARINC 858 Part 1.
- The DTLS session between the IPS Aircraft and the IPS Gateway has already been established, which is indicated with a dashed line.
- Receipt of D-STARTCNF and D-DATA ATNPKTs are acknowledged explicitly with a D-ACK ATNPKT. Optionally, receipt of a D-START is acknowledged with a D-ACK ATNPKT if an ACK timer expires before a D-STARTCNF ATNPKT is sent. In practice, depending on the timing, piggy-backed ATNPKT acknowledgements may be used.
- Application messages are small and ATNPKT fragmentation is not necessary. In addition, the ATNPKT user data field, which contains the application messages, may be compressed by the AICF.
- Every ARINC 620 uplink from the Ground ACARS Host contains an MA TEI, which requests a message assurance (MAS) response.

The message exchange diagrams emphasize the IPS Gateway that is being described in this document; however, other ground systems (e.g., legacy ARINC 620 processors) with which the IPS Gateway may interact are not shown. In addition, there may be additional ground-ground message exchanges between the IPS Gateway and the ACARS Host that are not shown in the diagrams for simplicity.

4.4.14.5.1 FANS-1/A AFN Application Example

This section presents a simple example of an AFN Logon procedure performed by an IPS Aircraft. The ANSP in this example is connected to the ACARS network. All traffic between the IPS Aircraft and the ANSP goes through the IPS Gateway. In the following figure, the message exchanges include:

1. The IPS Aircraft initiates an AFN Logon by sending a contact request to the ANSP. This is preceded by DTLS session establishment between the IPS Aircraft and the IPS Gateway.
2. The ANSP responds with an AFN acknowledgement accepting the logon request.

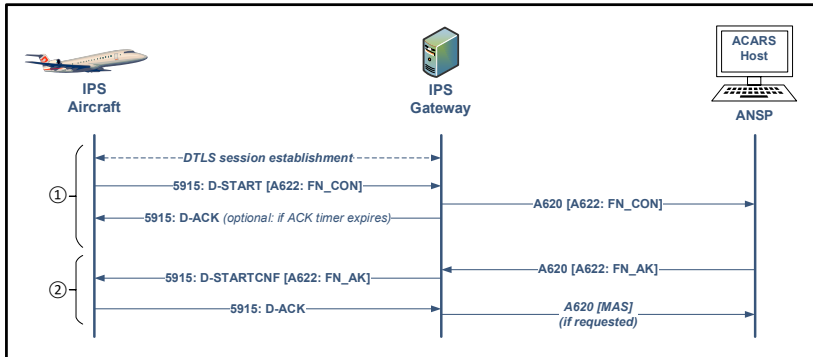

Figure 4-11 – FANS-1/A AFN Message Exchanges between an IPS Aircraft and an ACARS Host via an IPS Gateway

Commented [OML15]: [P2-M17-02 – M.Olive] - Harmonize "D-ACK subsequent to D-START" with final provisions in Doc. 9896 (applies to both text and figures)

Commented [OML16R15]: Pre-M18 – R.Dlouhy - I am not fully sure if the optional ACK after D-Start was accepted, I am sure the ACK after the D-Startcnf was.

Commented [OML17R15]: Pre- M18 – F.Wrobel – Included in official Doc 9896 Ed3 on ICAO Portal: Doc9896_Redline_3rd_Edition_Part_III_en_REFORMAT_10Mar2021.docx, Figure II-1-12

Commented [OML18R15]: M19 – Agreed to close since current text verified to be consistent with Doc. 9896.

4.0 IPS GATEWAY FOR ACARS

The following bullets provide a detailed description of the example scenario.

- The IPS Aircraft determines (e.g., via pre-configured address database or via a name lookup service) the IPv6 address that is associated with the ACARS ATC. This address is the IPv6 address of the IPS Gateway.
- The IPS Aircraft establishes a DTLS session with the IPS Gateway.
- The airborne AFN application generates an FN_CON application message, which the airborne AICF and IPS DS converts to a D-START ATNPKT that is sent to the IPS Gateway.
- The IPS Gateway maps the received D-START ATNPKT to a D-START indication primitive, which the IPS Gateway AICF converts to an ARINC 620 message that is sent to the Ground ACARS Host.
- Optionally, to avoid re-transmission of the D-START ATNPKT, the IPS Gateway sends a D-ACK ATNPKT to the IPS Aircraft if an ACK timer expires prior to sending the D-STARTCNF ATNPKT.
- The Ground ACARS Host replies with an FN_ACK message, which it sends to the IPS Gateway. This example assumes that the ARINC 620 message carrying FN_ACK contains an MA TEI (i.e., message assurance requested).
- The IPS Gateway AICF and IPS DS converts the received ARINC 620 message to a D-STARTCNF ATNPKT that is sent to the aircraft.
- The airborne IPS DS maps the received D-STARTCNF ATNPKT to a D-START response primitive, which the airborne AICF converts to an ACARS application message that is passed to the airborne AFN application.
- The IPS Aircraft sends a D-ACK ATNPKT to the IPS Gateway to explicitly acknowledge receipt of the D-STARTCNF ATNPKT and prevent unnecessary retransmissions.
- Upon receipt of the D-ACK ATNPKT from the IPS Aircraft, the IPS Gateway sends the requested message assurance message (MAS) to the Ground ACARS Host.

4.4.24.5.2 FANS-1/A CPDLC Application Example

This section presents a simple example of a FANS-1/A CPDLC session between an IPS Aircraft and a Ground ACARS Host. In the following figure, a DTLS session is already established between the IPS Aircraft and the IPS Gateway, and the CPDLC message exchanges include:

1. A CPDLC session is initiated by the ground, which sends a CR1 message
2. The IPS Aircraft replies with a CC1 message, at which point the CPDLC session is established
3. The ground and aircraft each send a single AT1 message containing CPDLC application data
4. Finally, the ground terminates the CPDLC session with a DR1 message

4.0 IPS GATEWAY FOR ACARS

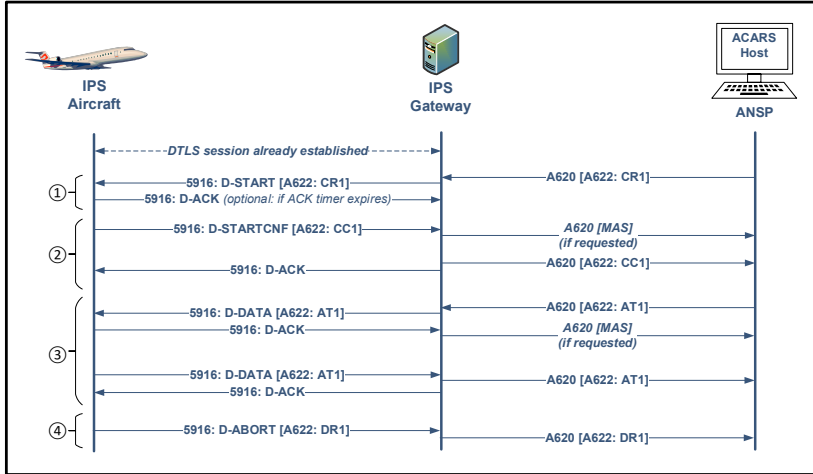

Figure 4-12 – FANS-1/A CPDLC Application Message Exchanges between an IPS Aircraft and an ACARS Host via an IPS Gateway

The following bullets provide a detailed description of the example scenario.

- The Ground ACARS Host sends an ARINC 620 CR1 message to the IPS Gateway. This example assumes that the ARINC 620 message carrying CR1 contains an MA TEI (i.e., message assurance requested).
- The IPS Gateway AICF and IPS DS converts the received ARINC 620 message to a D-START ATNPKT that is sent to the IPS Aircraft.
- The IPS Aircraft maps the received D-START ATNPKT to a D-START indication, which the airborne AICF converts to a CR1 ACARS application message that is passed to the airborne CPDLC application.
- Optionally, to avoid re-transmission of the D-START ATNPKT, the IPS Aircraft sends a D-ACK ATNPKT to the IPS Gateway if an ACK timer expires prior to sending the D-STARTCNF ATNPKT.
- The airborne CPDLC application responds with a CC1 ACARS application message, which the airborne AICF and IPS DS converts to a D-STARTCNF ATNPKT that is sent to the IPS Gateway.
- The IPS Gateway converts the received D-STARTCNF ATNPKT to a D-START response primitive, which the IPS Gateway AICF converts to an ARINC 620 message.
- Since receipt of the D-STARTCNF ATNPKT acknowledges that the CR1 message was received by the aircraft, the IPS Gateway sends MAS to the Ground ACARS Host, followed by the ARINC 620 message containing CC1.
 - Note: If the optional D-ACK is received prior to the D-STARTCNF, then the MAS is sent upon receipt of the D-ACK.
- The Ground ACARS Host sends an AT1 message to the IPS Gateway, where the IPS Gateway AICF and IPS DS converts it to a D-DATA ATNPKT that is sent to the IPS Aircraft.

Commented [ML19]: [P2-M19-02 – TBD] – Figure shows the interactions of the IPS Gateway with respect to synthesis of a Message Assurance Success MAS responses to FANS Host when MA TEI Request is contained in an FANS ACARS Host uplink. However what is not described are the MAS-Fail conditions and indications.

MAS Fail codes useful to Datacom FANS1/a are split into two main series 2xx and 3xx. If the CSP knows the uplink requesting MA has been attempted over the RF then a 3xx series code is generated in the MASF, while if no attempt has been made to transmit the uplink on a radio, then a 2xx series MAS code will be returned.

Additionally the FANS 1/A for Datacomm uses the new Deliver-By DB TEI for uplinks for Enroute Aircraft. When the DeliverBy time is exceeded, the CSPs will not attempt to transmit this message and will return either a 200 series or 300 series as defined in A620.

Commented [OML20R19]: See additions in Sections 4.3.2 and 4.4, and new example in Section 4.5.4.

4.0 IPS GATEWAY FOR ACARS

- The IPS Aircraft IPS DS and AICF converts the received D-DATA ATNPKT to an AT1 ACARS application message that is passed to the airborne CPDLC application.
- The IPS Aircraft replies with a D-ACK ATNPKT, which is sent back to the IPS Gateway to acknowledge the reception of the D-DATA ATNPKT. Upon receipt of the D-ACK ATNPKT, the IPS Gateway sends MAS to the Ground ACARS Host.
- The airborne CPDLC application also generates an AT1 message, which the airborne AICF and IPS DS converts to a D-DATA ATNPKT that is sent to the IPS Gateway.
- The IPS Gateway maps the received D-DATA ATNPKT to a D-DATA indication primitive, which the IPS Gateway AICF converts to an ARINC 620 message that is sent to the Ground ACARS Host.
- Finally, the IPS Aircraft terminates the CPDLC session with a DR1 message, which the airborne AICF and IPS DS converts to a D-ABORT ATNPKT that is sent to the IPS Gateway.
- The IPS Gateway maps the received D-ABORT ATNPKT to a D-ABORT indication primitive, which the IPS Gateway AICF converts to an ARINC 620 message that is sent to the Ground ACARS Host to close the CPDLC session. Note that if the D-ABORT containing the DR1 message is lost, the session will close automatically upon expiration of an application timer, which is consistent with ACARS application behavior.

4.4.34.5.3 FANS-1/A Multi-ANSP Example

The section presents a comprehensive example that integrates the AFN and CPDLC examples described in the previous sections and also illustrates handoff between the Current Data Authority (CDA) and Next Data Authority (NDA). In the following figure, the message exchanges include:

1. A DTLS session is established between the IPS Aircraft and IPS Gateway
2. The IPS Aircraft performs an AFN Logon with ANSP #1
3. ANSP #1 initiates a CPDLC connection request with the IPS Aircraft
4. The IPS Aircraft and ANSP #1 exchange CPDLC messages
5. ANSP #1 (CDA) instructs the IPS Aircraft to perform an AFN Logon with ANSP #2 (NDA)
6. The IPS Aircraft performs an AFN Logon with ANSP #2
7. The IPS Aircraft indicates to ANSP #1 that logon to ANSP #2 was successful, and it also sends ANSP #1 a CPDLC disconnect request
8. ANSP #2 initiates a CPDLC connection request with the IPS Aircraft
9. IPS Aircraft and ANSP #2 exchange CPDLC message

4.0 IPS GATEWAY FOR ACARS

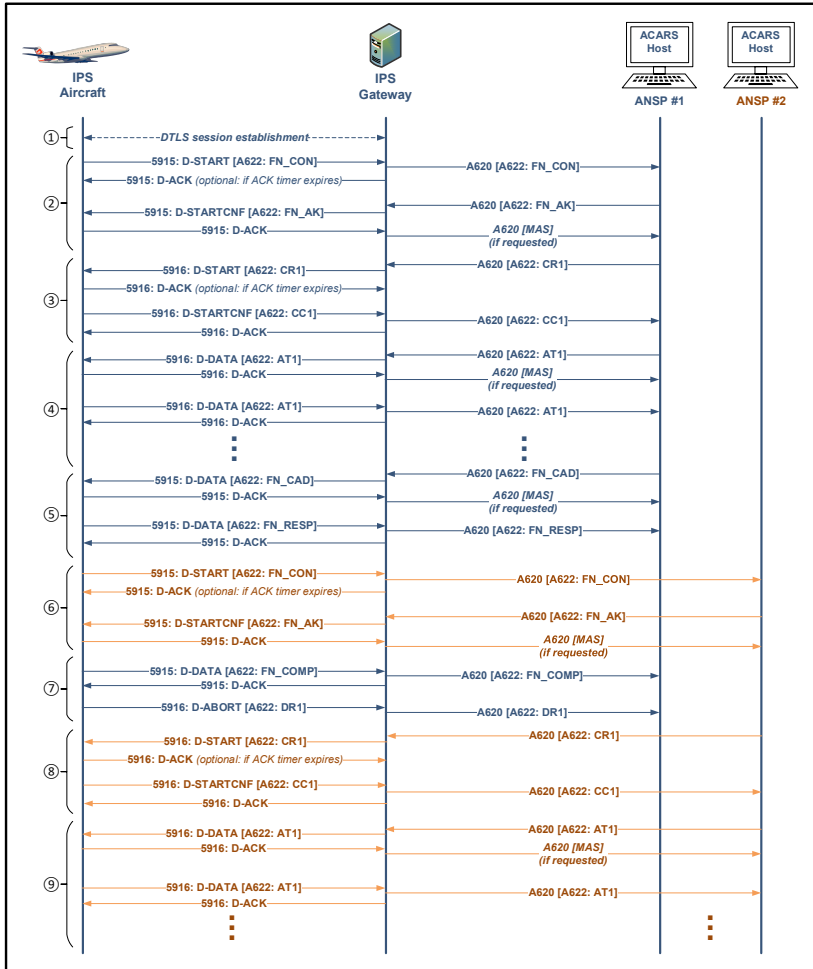

Figure 4-13 – Comprehensive FANS-1/A Example Showing AFN and CPDLC Application Message Exchanges between an IPS Aircraft and two ACARS Hosts via an IPS Gateway

4.5.4 FANS-1/A CPDLC Application Uplink Failure Example

This section presents a simple example of an uplink failure for a FANS-1/A CPDLC message exchanges between an IPS Aircraft and a Ground ACARS Host. In the following figure, a DTLS session is already established between the IPS Aircraft and the IPS Gateway, a CPDLC session is already established between the IPS Aircraft and the Ground ACARS Host, and CPDLC message exchanges are in progress.

Commented [OML21]: p/o changes to address P2-M19-02

4.0 IPS GATEWAY FOR ACARS

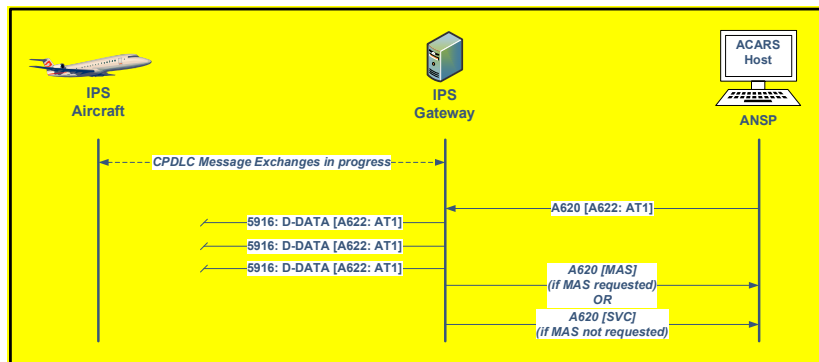

Figure 4-14 – FANS-1/A Example Showing CPDLC Uplink Failure

The following bullets provide a detailed description of the example scenario.

- The Ground ACARS Host sends an AT1 message to the IPS Gateway, where the IPS Gateway AICF and IPS DS converts it to a D-DATA ATNPKT that is sent to the IPS Aircraft.
- When no acknowledgement is received from the IPS Aircraft, the IPS Gateway attempts to retransmit the message. If no acknowledgements are received, this process is repeated per the configured number of retransmissions (e.g., two retransmissions in this example).
- If no acknowledgement is received for the original and retransmitted messages, the IPS Gateway alerts the Ground ACARS Host sender via:
 - If message assurance was requested, the IPS Gateway generates a message assurance report (MAS) containing the intercept reason code for the undeliverable uplink, or
 - If message assurance was not requested, the IPS Gateway generates an undeliverable uplink service (SVC) message containing the intercept reason code.

5.0 IPS GATEWAY FOR OSI

5.0 IPS GATEWAY FOR OSI

5.1 Principle of Operation

While ATN/IPS uses substantially different protocols than ATN/OSI, it will provide the same Dialogue Service Application Programming Interface (API) as ATN/OSI. Consequently, the ATN applications do not require changes when porting to IPS, and the IPS-to-OSI Gateway function may be placed above the Dialogue Service API. This is illustrated in Figure 5-1.

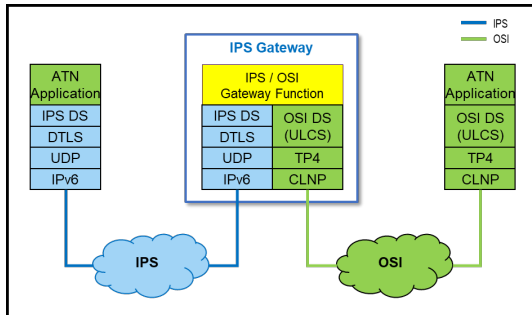

Figure 5-1 – IPS Host an OSI End System Communicating via an IPS Gateway

As shown, the IPS Gateway message forwarding function exchanges Dialogue Service Primitives with the local instances of IPS and OSI Dialogue Services. Then, those DS instances are responsible for exchanging the messages over the network using appropriate protocols.

The IPS Dialogue Service exchanges ATNPkTs over UDP, and DTLS provides application-level authentication and message integrity. The details of the operation of IPS DS can be found in ICAO Doc. 9896.

The OSI Dialogue Service, as defined in ICAO Doc. 9880 Part III, encapsulates OSI presentation and session layers. The connection-oriented TP4 transport protocol is used to reliably deliver messages over the network.

5.2 Advertisement of Proxy Address

5.2.1 General Case

Each ATN application host is uniquely identified by either a 24-bit ICAO ID or by an ICAO Ground Facility Designator. Either of these two identifiers is mapped to a network address, in its native network domain, that is unique for a given ATN application. For an OSI Host this is Network Service Access Point (NSAP) and Transport Selector (TSEL), while IPS Hosts use an IPv6 address and UDP port number.

The IPS Gateway maintains an address mapping table that associates the native addresses with a proxy addresses for each ATN application, including:

- For OSI end systems, native NSAPs are associated with proxy IPv6 addresses
- For IPS Hosts, native IPv6 addresses associated with proxy NSAPs.

5.0 IPS GATEWAY FOR OSI

Before any communication via a gateway can happen, the IPS Gateway must distribute the proxy addresses in the respective networks. The proxy address distribution at the ATN/IPS side can be realized in various ways (e.g., via the IPS mobility solution), and the approach may be implementation specific and depend on the IPS Gateway location within the IPS ground infrastructure. ATN/OSI uses the Inter Domain Routing Protocol (IDRP) as the routing protocol and in principle, this protocol must be used to distribute the proxy NSAPs of IPS Hosts in the ground OSI network.

Certain native addresses are fixed and well-known in advance, for example addresses assigned to ground entities such as Ground IPS Hosts and OSI End Systems. IPS Gateways can be configured to use a static mapping between those addresses and the corresponding proxy addresses. For example, an OSI End System may have a single native NSAP that is mapped to a single proxy IPv6 address. Since both addresses are well-known in advance, they can be configured statically in the IPS Gateway, which advertises the proxy IPv6 address in the IPS domain.

On the other hand, some native addresses are not known in advance. For example, addresses of Airborne IPS Hosts and Airborne OSI End Systems typically remain unknown until they are explicitly announced to the ground via applications such as Contact Management (CM, refer to Section 5.2.2). For example, the end addresses of ATN CPDLC and ADS-C applications become known to the ground after the CM Logon procedure. The IPS Gateway maps the native addresses included in CM application messages to the corresponding proxy addresses in real time and, if necessary, advertises those proxy addresses in the corresponding network domains. This is case is illustrated in Figure 5-2, which shows an example of an IPS Aircraft attaching to the IPS network and communicating with a Ground OSI End System via the IPS Gateway, as follows:

- A. In the initial state, the IPS Gateway distributes the proxy addresses for fixed nodes in the respective network domains. Specifically, the proxy IPv6 address for the Ground OSI End System is distributed in the IPS domain. At this point, the IPS Aircraft is disconnected from the IPS internetwork and its IPv6 address(es) are not known. The IPS Gateway is not aware of the IPS Aircraft and its address(es).
- B. Once the IPS Aircraft is attached to the IPS internetwork, its IPv6 address(es) become reachable within the IPS domain. However, this does not mean that the IPS Gateway and/or other IPS hosts are aware of that fact. In certain network configurations, such as an IPS Gateway hosted in a CSP network, the IPS Gateway may learn the IPS Aircraft's IPv6 address(es) and that the address(es) are now reachable; however, this cannot be assumed generically for all IPS deployments.
- C. When the IPS Aircraft attempts to communicate with the Ground OSI End System, it uses the proxy IPv6 address of that Ground OSI End System. Since that proxy address is distributed by the IPS Gateway, the IPS internetwork directs the traffic there. The point when the downlink application traffic reaches the IPS Gateway is when the IPS Aircraft's IPv6 address(es) become known to the IPS Gateway. The IPS Gateway generates one or more proxy NSAP addresses for the IPv6 address(es), and it distributes them in the OSI domain (via IDRP).

5.0 IPS GATEWAY FOR OSI

D. The proxy NSAP addresses from the prior step allow the uplink application traffic that is sent by Ground OSI End System to reach the IPS Gateway and the IPS Aircraft.

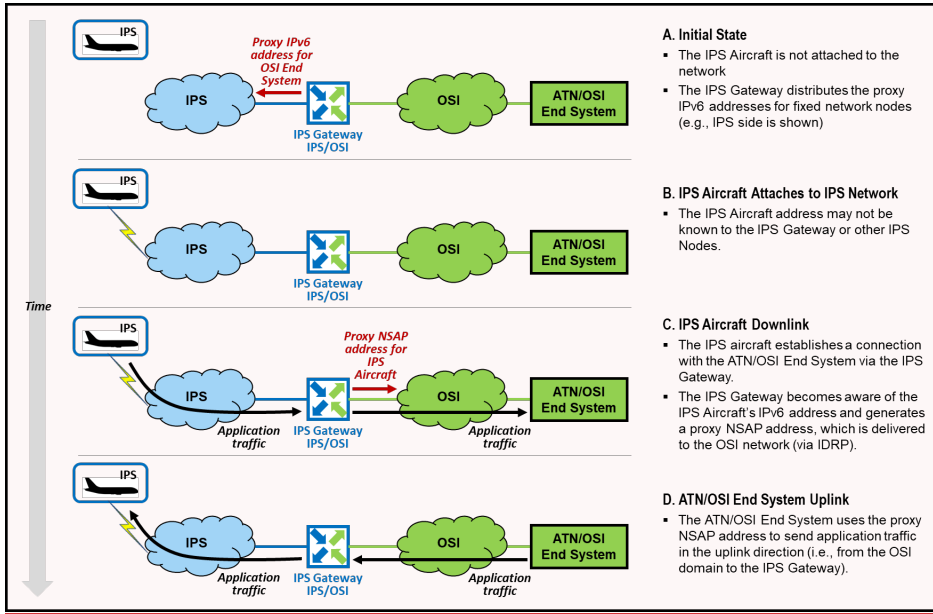

Figure 5-2 – Distribution of Proxy Addresses for Mobile Nodes

When mapping native addresses to proxy addresses, the IPS Gateways may use Domain Name Service (DNS) or Simple Name Lookup Service. These services may be provided by an external entity or they may be provided by the IPS Gateway itself.

The mapping between the NSAP addresses and IPv6 addresses is based on the addressing schemes, and the way in which the mapping is achieved is implementation-specific and outside the scope of this document.

5.2.2 Context Management Application Considerations

The Context Management (CM) application is generally used by ATC ground systems to trigger a flight data processing system to check, at a minimum, that the aircraft logging on has a correctly filed flight plan, is expected in the airspace, and has the correct flight parameters (e.g., call sign). These checks ensure that the flight data in the ground system corresponds to the aircraft attempting to log on and that the flight data processing system is prepared to interact with the aircraft.

In addition, CM has the ability to convey NSAP addresses, application identifiers, and version numbers for supported applications. For IPS, it is not necessary for the CM application to convey the IPv6 addresses of the various applications that the aircraft is capable of supporting. While an IPv6 address could be accommodated using the format of an existing NSAP address, the need to identify the address is

Commented [OML22]: [P2-M17-03 – F.Wrobel] - Consider adding a diagram to help convey the concepts in Paragraph 5.

Commented [OML23]: [P2-M17-04 - TBD] - Need to think about how to best detect (and prevent) erroneous/duplicate address. Putting the conversion on the ground should help to eliminate this problem. (With current OSI deployment, SITA has seen cases where aircraft are configured with the same NSAP addresses (and even the same 24-bit address).) NOTE: This guidance may apply more broadly to all systems.

Commented [OML24R23]: 13-APR: Consider addressing in Part 1 as part of P1-S01-10
M20: Relocate to Section 3.x since duplicate addresses can apply to any type of IPS GW. Update text to reflect address cross-check with associated aircraft certificate.
M21: Circulate for review among DSP/CSP
Mar-22: Reviewed text. Greg to coordinate with SITA for improvements to proposed process.

5.0 IPS GATEWAY FOR OSI

not required since the address can be obtained via ground-ground IPS management services.

For an OSI aircraft using an IPS Gateway, the key parameters are the Called and Calling Peer IDs contained in the dialogue service primitives. These parameters can be used to correlate, either using a local database or via IPS management message exchanges, the ground system's IPv6 address that the IPS Gateway will use for routing.

In a fully IPS environment, the address of the applications can be determined in a similar manner. The contents of the CM Logon Application Protocol Data Unit (APDU) can be used to convey supported applications and versions to the ground end system, but the NSAP addresses normally carried in the CM Logon are not necessary.

For an IPS Aircraft communicating via an IPS/OSI Gateway, a local database may be used to determine the OSI addresses of Ground End System. An OSI Ground End System may change its addresses for all aircraft to be the OSI address of the IPS/OSI Gateway. This approach allows uplinks (e.g., CPDLC) to be addressed directly to the IPS/OSI Gateway, which then uses the operational association to determine the corresponding IPS aircraft address.

Note that address handling for the CM Contact service would operate in a manner similar to CM Logon.

5.3 Mapping of Dialogue Service Primitive Parameters

In the idle state, the IPS Gateway waits for network connections from the remote applications. An incoming connection from a remote application (IPS or OSI) is accepted and a Dialogue Service session is established.

Upon reception of a D-START primitive (i.e., a D-START indication) the IPS Gateway extracts the Destination Peer ID and determines the network address of the peer in the other network domain. For example, if a D-START primitive is received in the IPS domain, then the IPS Gateway must determine the address of the destination peer in the OSI domain. Once the destination network address is determined, the IPS Gateway initiates a new Dialogue Service session to that peer mapping the received D-START indication to the D-START request.

Table 5-1 shows the DS primitives that are exchanged with the respective instances of the IPS and OSI Dialogue Services and the minimum processing performed by the IPS Gateway function. Note that the IPS Gateway function may be implemented using different application service entity (ASE) entry points, either at the user-level boundary or at the dialogue service boundary. In either case, the overall behavior of the IPS Gateway function should be compatible with the behavior shown in the following table, which reflects the dialogue service boundary approach.

5.0 IPS GATEWAY FOR OSI

Table 5-1 – Mapping of DS Primitives in the IPS Gateway Function

DS Primitive Received from Source DS Instance	IPS Gateway Protocol and Association Processing	DS Primitive sent to Destination DS Instance
D-START ind (indication)	<p>Create a new operational association context between the aircraft and ground end systems as described in Section 3.4.1.</p> <p>Inspect the Called Peer ID attribute [Note 1] in the received primitive and determine the network address of the target host (end-system) in the destination network domain [Note 2].</p> <p>Inspect the Calling Peer ID attribute [Note 1] and determine the proxy address of the source host (end-system) in the destination network domain [Notes 2, 3].</p> <p>Map the source D-START ind primitive to the destination D-START req primitive. Both primitives use the same attributes and the mapping is one-to-one.</p> <p>Create a new session in the destination DS and deliver the D-START req primitive to the destination DS.</p>	D-START req (request)
D-START cnf (confirmation)	<p>Find the existing operational association context and update as necessary.</p> <p>Map the source D-START cnf primitive to the destination D-START rsp primitive. Both primitives use the same attributes and the mapping is one-to-one.</p> <p>Deliver the D-START rsp primitive to the destination DS.</p> <p>If the value of the Result attribute in the D-START cnf primitive is REJECTED, mark the operational association context as pending destruction [Note 4].</p>	D-START rsp (response)
D-DATA ind	<p>Find the existing operational association context.</p> <p>Map the source D-DATA ind primitive to the destination D-DATA req. Both primitives use the same attributes and the mapping is one-to-one.</p> <p>Deliver the D-DATA req primitive to the destination DS.</p>	D-DATA req
D-END ind	<p>Find the existing operational association context and update as necessary.</p> <p>Map the source D-END ind primitive to the destination D-END req. Both primitives use the same attributes and the mapping is one-to-one.</p> <p>Deliver the D-END req primitive to the destination DS.</p>	D-END req

5.0 IPS GATEWAY FOR OSI

DS Primitive Received from Source DS Instance	IPS Gateway Protocol and Association Processing	DS Primitive sent to Destination DS Instance
D-END cnf	<p>Find the existing operational association context and update as necessary.</p> <p>Map the source D-END cnf primitive to the destination D-END rsp. Both primitives use the same attributes and the mapping is one-to-one.</p> <p>Deliver the D-END rsp primitive to the destination DS.</p> <p>If the value of the Result attribute in the D-END cnf primitive is ACCEPED, mark the operational association context as pending destruction [Note 4].</p>	D-END rsp
D-ABORT ind	<p>Find the existing operational association context and update as necessary.</p> <p>Map the source D-ABORT ind primitive to the destination D-ABORT req. Both primitives use the same attributes and the mapping is one-to-one.</p> <p>Deliver the D-ABORT req primitive to the destination DS.</p> <p>Mark the operational association context as pending destruction [Note 4].</p>	D-ABORT req
D-P-ABORT ind	<p>Find the existing operational association context and update as necessary.</p> <p>Generate a D-ABORT req primitive, deliver it to the destination DS, and mark the session as pending destruction [Note 4].</p> <p><i>OR</i></p> <p>Destroy the operational association context immediately.</p>	D-ABORT req <i>OR</i> None
<p>Note 1: The value of Called/Calling Peer ID attribute is either the ICAO 24-bit ID for aircraft or the ICAO Ground Facility Designator for ground hosts (end-systems).</p> <p>Note 2: The network address in the OSI network domain consists of the NSAP and TSEL. The network address in the IPS network domain consists of IPv6 address and UDP port number.</p> <p>Note 3: The IPS Gateway acts as a proxy for the Calling Peer in the destination network domain, therefore it must act as a network node in that network domain that uses the proxy addresses. Those proxy addresses (or prefixes) must also be distributed in the destination network domain using protocols specific to that domain (e.g., IDR for OSI).</p> <p>Note 4: The source DS session that emits: (a) D-START cnf with Result=REJECTED, (b) D-END cnf with Result=ACCEPTED, or (c) D-ABORT ind, may terminate as soon as those primitives are processed. This is due to the internal state machines in the Dialogue Service. The IPS Gateway session and the destination DS must be kept active for the time required to reliably communicate those primitives to the remote DS peer in the destination network domain.</p>		

Since the applications are the same at both the IPS and OSI sides, the IPS Gateway does not need to inspect or use application data that is carried inside DS Primitives.

5.0 IPS GATEWAY FOR OSI

The Provider Abort (D-P-ABORT) primitive in the last row in Table 5-1 is used in situations where one of the connections to the remote peers has been broken. This can happen as a result of breaking a TP4 connection at the OSI side or reaching the retransmission limit of ATNPKT at the IPS side. In such cases, two actions are possible:

- The IPS Gateway sends a D-ABORT message over the remaining active DS session. In this case the IPS Gateway acts on behalf of the disconnected remote application. The Originator field in the D-ABORT message should be set to Provider.
- The IPS Gateway terminates the remaining active session without sending any message to the remote peer. Consequently, the remote DS peer will detect the broken connection/session and generate a Provider Abort to its local user.

Figure 5-3 below shows an example of exchanging DS Primitives between the IPS Gateway function and the two internal instances of Dialogue Service: IPS and OSI. In the figure, Panel A illustrates a session initiated by the IPS side, and Panel B illustrates a session initiated by the OSI side.

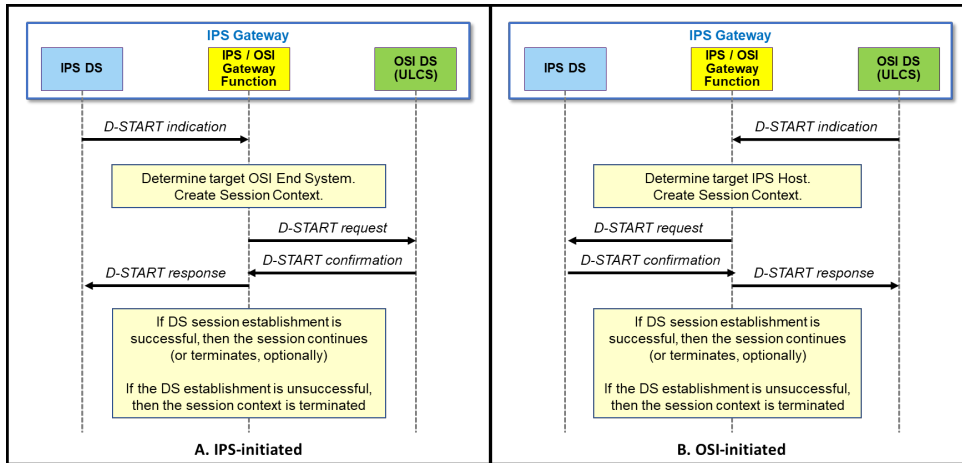

Figure 5-3 – Example DS Primitive Mapping in an IPS/OSI Gateway

As shown, if the DS session is established successfully, then the session can continue or be terminated depending on the value of the Result field in the D-START confirmation primitive. If the DS session is not established successfully, then either the IPS or OSI Dialogue Service component issues a D-P-ABORT to the IPS Gateway Function. This primitive is mapped to a D-ABORT request with the Originator parameter set to Provider.

For each application session, the IPS Gateway maintains a context that identifies the participants of that session. The context may maintain some or all of the following information:

- Peer ID of the application host in the OSI domain. The Peer ID can be either a 24-bit ICAO ID or a Ground Facility Designator.

5.0 IPS GATEWAY FOR OSI

- Peer ID of the application host in the IPS domain.
- Native address (NSAP and TSEL) of the application host in OSI domain.
- Proxy address of the OSI application host in IPS domain (IPv6 address and UDP port number). This address is assigned to the IPS Gateway.
- Native address of the application in the IPS domain (IPv6 address and UDP port number).
- Proxy address of the application in OSI domain (NSAP and TSEL). This address is assigned to the IPS Gateway.
- ATN application qualifier and the application version.
- ATN Quality of Service (QoS) information.

5.4 State Tables

5.4.1 Air-Initiated Applications

The tables and associated diagrams in this section describe the state mapping for the air-initiated applications. The following notes are applicable to each of the state tables contained in this section:

- The state tables assume the D-START Version Number parameter is less than or equal to the CM-Ground-ASE (Application Service Entry) Version Number. The CM-Ground-ASE Version Number of the IPS Gateway must match the CM-Ground Application Version Number served by the IPS Gateway. For other Version Number cases, refer to ICAO Doc. 9880 CM-Ground-ASE Protocol and State Tables.
- The association processing described in the state table ensures that a one-to-one association is maintained between the aircraft and the ground system. The ground may still reject a CM-Logon Request for reasons such as the aircraft not having a valid flight plan.
- As described previously in Section 5.3, the IPS Gateway Function may be implemented using different application service entity (ASE) entry points, either at the user-level boundary or at the dialogue service boundary. The tables and associated figures in this section reflect the dialogue service boundary approach.

The illustrative diagrams in this section use the following notation:

- IPS message flow: **UDP port number: DS-PRIMITIVE [application message type]**, which represents ATNPkTs that are exchanged over a DTLS-secured session
- OSI message flow: **APDU [application message type]**, which represents OSI application layer APDUs that are exchanged over the TP4 transport protocol.

5.4.1.1 IPS Aircraft Communicating with a Ground ATN/OSI End System

For an IPS Aircraft communicating with an ATN/OSI Ground End System, the state mapping for the air-initiated CM Logon service is provided in Table 5-2 and shown in [Figure 5-4](#) and [Figure 5-5](#).

5.0 IPS GATEWAY FOR OSI

Table 5-2 – IPS to ATN/OSI State Mapping – CM Logon

IPS		OSI
CM – Ground Processing / State	IPS GW Protocol and Association Processing	CM – Aircraft Processing / State
→ Per Doc. 9896 IPS DS for RECEIVE (D-START) Create D-START ind primitive	→ Refer to Table 5-1 for D-START ind primitive (source DS instance) to D-START req primitive (destination DS primitive)	→ Per Doc. 9880 for receipt of a D-START req primitive
← Per Doc. 9896 IPS DS for receipt of a D-START rsp primitive Create D-STARTCNF ATNPKT	← Refer to Table 5-1 for D-START cnf primitive (source DS instance) to D-START rsp primitive (destination DS primitive)	← Per Doc. 9880 for receipt of a D-START cnf primitive

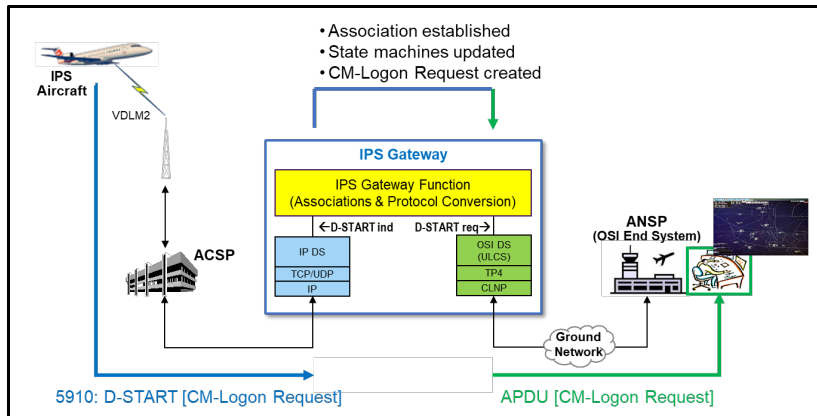

Figure 5-4 – CM Logon Downlink from an IPS Aircraft to an OSI End System

5.0 IPS GATEWAY FOR OSI

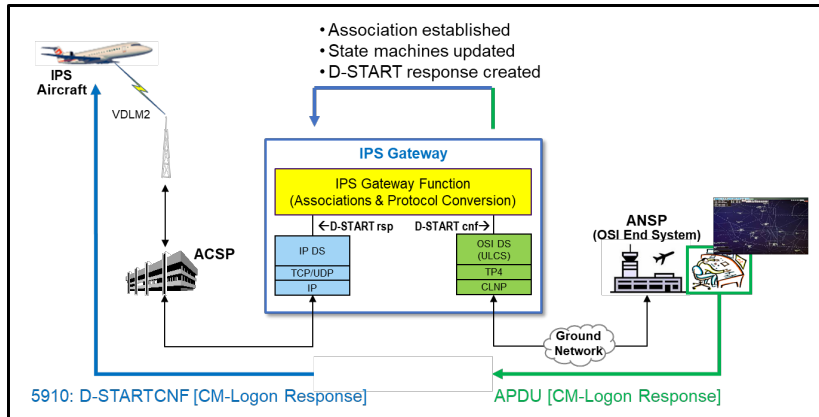

Figure 5-5 – CM Logon Uplink Response from an OSI End System to an IPS Aircraft

5.4.1.2 ATN/OSI Aircraft Communicating with a Ground IPS Host

For an ATN/OSI Aircraft communicating with a Ground IPS Host, the state mapping for the air-initiated CM Logon service is provided in Table 5-3 and shown in [Figure 5-6](#) and [Figure 5-7](#).

Table 5-3 – ATN/OSI to IPS State Mapping – CM Logon

OSI	IPS
CM – Ground Processing / State	CM – Aircraft Processing / State
→	→
Per Doc. 9880 for receipt of a D-START ind primitive	Per Doc. 9896 IPS DS for receipt of a D-START req Create D-START ATNPKT
←	←
Per Doc. 9880 for receipt of a D-START rsp primitive	Per Doc. 9896 IPS DS for RECEIVE (D-STARTCNF) Create D-START cnf

5.0 IPS GATEWAY FOR OSI

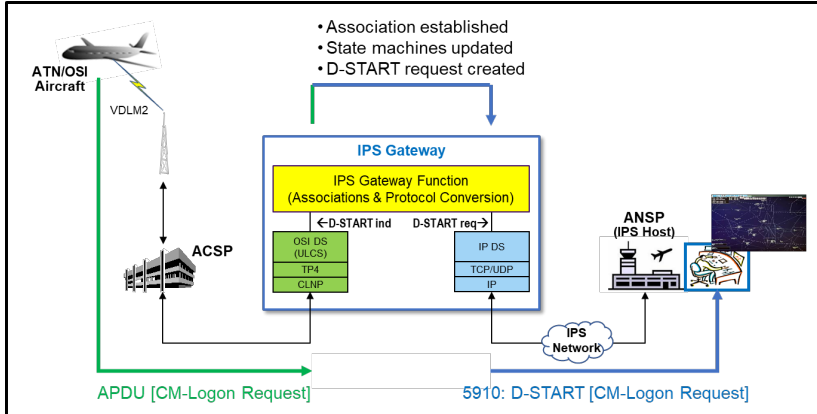

Figure 5-6 – CM Logon Downlink from an OSI Aircraft to a Ground IPS Host

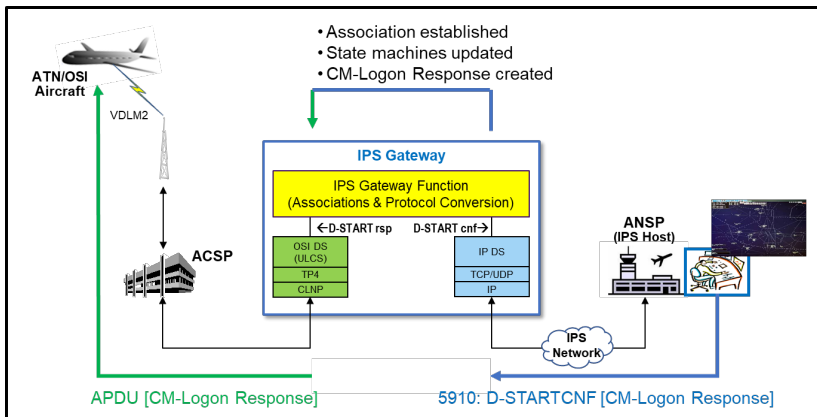

Figure 5-7 – CM Logon Uplink Response from a Ground IPS Host to an OSI Aircraft

5.4.2 Ground-initiated Applications

The tables and associated diagrams in this section describe the state mapping for ground-initiated applications. The following notes are applicable to each of the state tables contained in this section:

- The association processing described ensures that a one-to-one association is maintained between the aircraft and the ground end system.
- As described previously in Section 5.3, the IPS Gateway Function may be implemented using different application service entity (ASE) entry points, either at the user-level boundary or at the dialogue service boundary. The tables and associated figures in this section reflect the dialogue service boundary approach.

5.0 IPS GATEWAY FOR OSI

The illustrative diagrams in this section use the message flow notation defined in Section 5.4.1.

5.4.2.1 Ground ATN/OSI End System Communicating with an IPS Aircraft

For an ATN/OSI Ground End System communicating with an IPS Aircraft, the state mapping for the ground-initiated CPDLC Start or CM Contact service is provided in Table 5-4 and shown in Figure 5-8 and Figure 5-9.

Table 5-4 – ATN/OSI to IPS State Mapping – CPDLC Start or CM Contact

IPS		OSI
CPDLC or CM – Ground Processing / State	IPS GW Protocol and Association Processing	CPDLC or CM – Aircraft Processing / State
← Per Doc. 9896 IPS DS for RECEIVE D-START req Create D-START ATNPKT	← Refer to Table 5-1 for D-START ind primitive (source DS instance) to D-START req primitive (destination DS primitive)	← Per Doc. 9880 for receipt of a D-START ind primitive
→ Per Doc. 9896 IPS DS for RECEIVE (D-STARTCNF) Create D-START cnf primitive	→ Refer to Table 5-1 for D-START cnf primitive (source DS instance) to D-START rsp primitive (destination DS primitive)	→ Per Doc. 9880 for receipt of a D-START rsp primitive

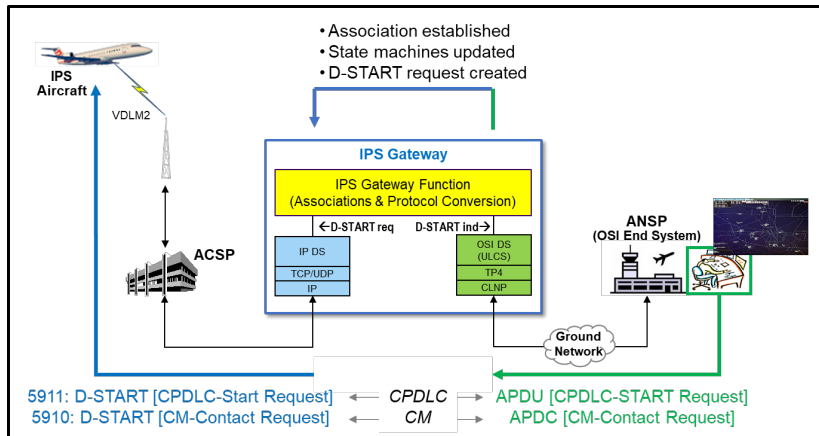

Figure 5-8 – CPDLC Start or CM Contact Uplink Request from a Ground OSI End System to an IPS Aircraft

5.0 IPS GATEWAY FOR OSI

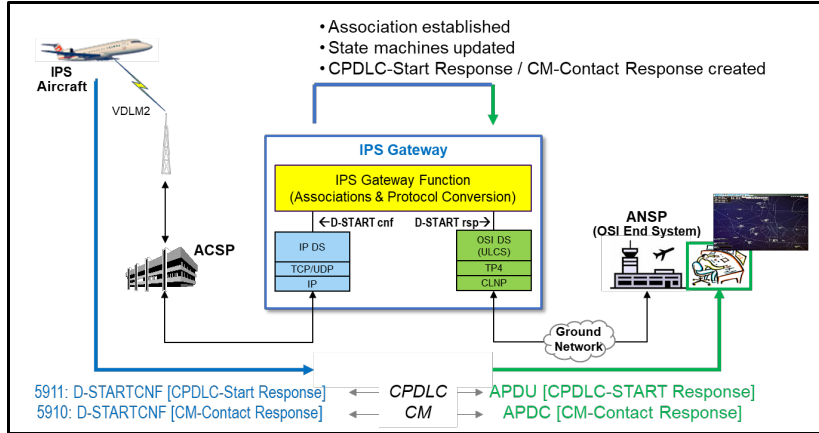

Figure 5-9 – CPDLC Start or CM Contact Downlink Response from a Ground OSI End System to an IPS Aircraft

5.4.2.2 Ground IPS Host Communicating with an ATN/OSI Aircraft

For a Ground IPS Host communicating with an OSI Aircraft, the state mapping for the ground-initiated CPDLC Start or CM Contact service is provided in Table 5-5 and shown in Figure 5-10 and Figure 5-11.

Table 5-5 – IPS to ATN/OSI State Mapping – CPDLC Start or CM Contact

OSI		IPS
CPDLC or CM – Ground Processing / State	IPS GW Protocol and Association Processing	CPDLC or CM – Aircraft Processing / State
← Per Doc. 9880 for receipt of a D-START req primitive	← Reference Table 5-1 for D-START ind primitive (source DS instance) to D-START req primitive (destination DS instance)	← Per Doc. 9896 IPS DS for RECEIVE (D-START) Create D-START ind primitive
→ Per Doc. 9880 for receipt of a D-START cnf primitive	→ Reference Table 5-1 for D-START cnf primitive (source DS instance) to D-START rsp primitive (destination DS instance)	→ Per Doc. 9896 IPS DS for receipt of a D-START rsp Create D-STARTCNF ATNPKT

5.0 IPS GATEWAY FOR OSI

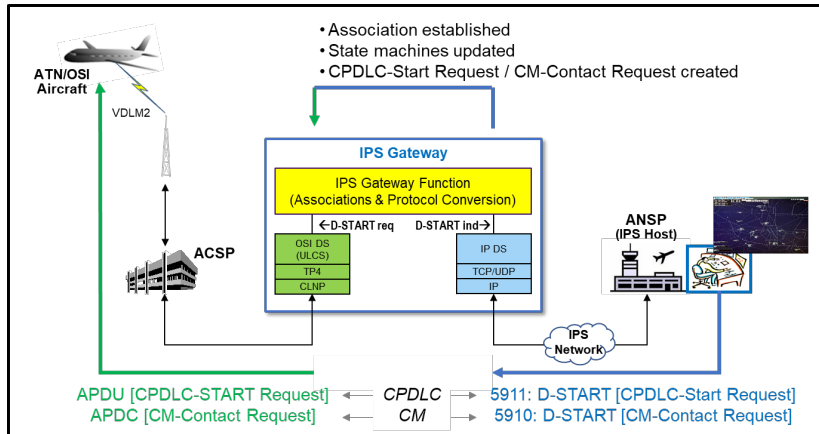

Figure 5-10 – CPDLC Start or CM Contact Uplink Request from a Ground IPS Host to an OSI Aircraft

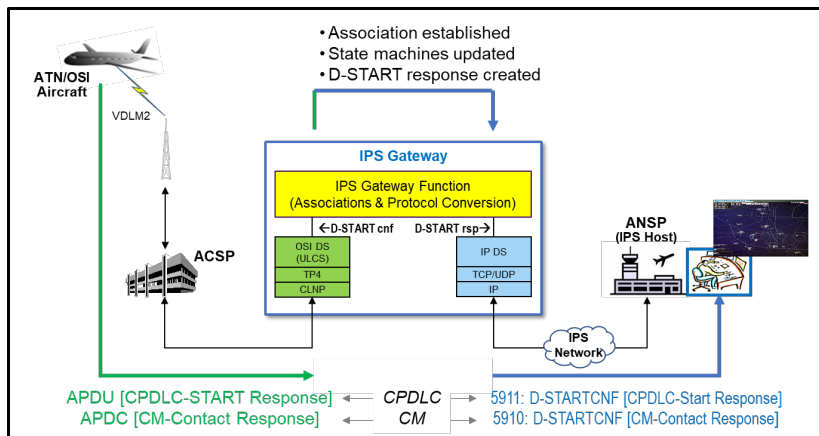

Figure 5-11 – CPDLC Start or CM Contact Downlink Response from a Ground IPS Host to an OSI Aircraft

5.5 Message Exchange Examples

The following subsections present examples of the communication between IPS Hosts and OSI End Systems via an IPS/OSI Gateway. The sequence diagrams show the messages that are exchanged over IPS and OSI networks. The diagrams use the message flow notation defined in Section 5.4.1.

The following are assumed in each of the examples:

- “IPS Aircraft” represents the Airborne IPS System per ARINC 858 Part 1.
- The DTLS session between the IPS Aircraft and the IPS Gateway is established successfully, which is indicated with a dashed line.

5.0 IPS GATEWAY FOR OSI

- The detailed TP4 protocol data units (PDUs) are not shown, and the TP4 connection and disconnection handshakes are indicated with a dashed line.
- Only the OSI APDU containing application data is shown; a complete description of all OSI Upper Layer Communication Services (ULCS) PDU exchanges can be found in ICAO Doc. 9880, Sub-Volume IV.
- Receipt of D-STARTCNF, D-DATA, and D-ENDCNF ATNPkTs are acknowledged explicitly with a D-ACK ATNPkT. [Optionally, receipt of a D-START is acknowledged with a D-ACK ATNPkT if an ACK timer expires before a D-STARTCNF ATNPkT is sent.] In practice, depending on the timing, piggy-backed ATNPkT acknowledgements can be used.
- Application messages are small and ATNPkT fragmentation is not necessary.

Commented [OML25]: [P2-M17-02] - Harmonize "D-ACK subsequent to D-START" with final provisions in Doc. 9896 (applies to both text and figures) **OSI communication protocol**

Commented [OML26R25]: M19 – Agreed to close since current text verified to be consistent with Doc. 9896.

The message exchange diagrams emphasize the IPS Gateway that is being described in this document. There may be additional ground-ground message exchanges between the IPS Gateway and the OSI End System that are not shown on the diagrams for simplicity.

5.5.1 Air-Initiated CM Logon Example

5.5.1.1 IPS Aircraft Communicating with a Ground ATN/OSI End System

This section presents a basic CM Logon procedure using the CM application. The procedure consists just of two messages exchanged between the applications. The following DS Primitives are generated by the two applications:

1. The airborne CM application generates a D-START request that contains a CM-Logon Request message as the application data. This is preceded by a DTLS session being established between the IPS Aircraft and IPS Gateway.
2. The ground CM application replies with D-START response that contains a CM-Logon Response. The Result attribute of this DS primitive contains the value Reject, which is an indication to terminate the application session.

Each application issues the dialogue service primitives to their local DS. [Figure 5-12](#) shows the messages exchanged over the network where the airborne application uses IPS and the ground application uses OSI.

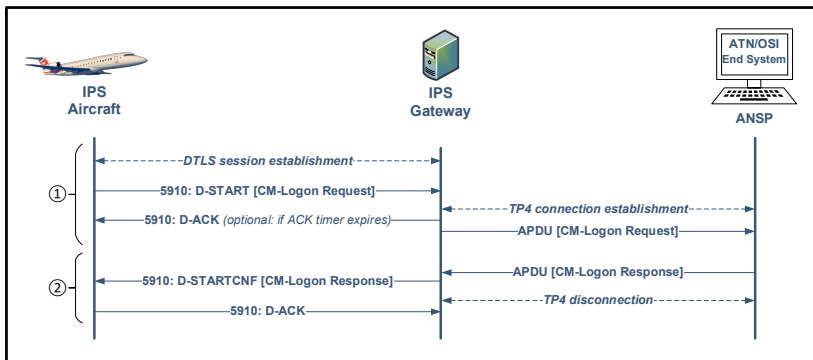

Figure 5-12 – CM Logon Message Exchanges between an IPS Aircraft and an ATN/OSI End System via an IPS Gateway

5.0 IPS GATEWAY FOR OSI

The following bullets provide a detailed description of the example scenario:

- The IPS Aircraft determines (e.g., via pre-configured address database or via name lookup service) the IPv6 address of the correspondent ground application. Since the ground application is located in the OSI network, the address is the IPv6 address of the IPS Gateway.
- The IPS Aircraft establishes a DTLS session with the IPS Gateway.
- The airborne CM application generates a CM-Logon Request, which is converted to a D-START ATNPKT and sent to the IPS Gateway.
- The IPS Gateway maps the received D-START ATNPKT to a D-START indication primitive and determines the OSI ground application address (NSAP and TSEL).
- Optionally, to avoid re-transmission of the D-START ATNPKT, the IPS Gateway sends a D-ACK ATNPKT to the IPS Aircraft if an ACK timer expires prior to sending the D-STARTCNF ATNPKT.
- The IPS Gateway establishes a TP4 connection with the Ground OSI End System.
- The IPS Gateway sends an APDU that contains the CM-Logon Request message to the Ground OSI End System.
- Upon receipt of the message, the Ground OSI End System initiates the CM application session, converts the session information and APDU to a D-START indication primitive, which it forwards to the ground CM application.
- The ground CM application generates a D-START response primitive that contains the CM-Logon Response. The Result attribute of this primitive contains the value Rejected, indicating that the application wants to close the session.
- The Ground OSI End System sends an APDU containing a CM-Logon Response message to the IPS Gateway over the TP4 connection.
- Upon receipt of the CM-Logon Response by the IPS Gateway, the TP4 connection can be closed.
- The IPS Gateway converts the CM-Logon Response to a D-STARTCNF ATNPKT that is sent to the IPS Aircraft. The Result field set to Reject and the application data contains the converted CM-Logon Response message.
- The IPS Aircraft maps the received D-STARTCNF ATNPKT to a D-START response primitive that is passed to the airborne CM application.
- The IPS Aircraft sends a D-ACK ATNPKT to the IPS Gateway to explicitly acknowledge receipt of the D-STARTCNF ATNPKT and prevent unnecessary retransmissions.

In [Figure 5-12](#), note that the IPS-side D-ACK ATNPKT is used to explicitly acknowledge the reception the D-STARTCNF ATNPKT and prevent possible retransmissions. Depending on the timing, piggy-backed acknowledgements are also possible. It is also assumed that no packets are lost. In practice, depending on the network conditions, ATNPKTs may be lost and this would trigger retransmissions.

5.0 IPS GATEWAY FOR OSI

5.5.1.2 ATN/OSI Aircraft Communicating with a Ground IPS Host

The example described in this section illustrates the CM Logon procedure performed between a legacy OSI Aircraft and an IPS-enabled ATC Host. The following DS Primitives are generated by the two applications:

1. The airborne CM application generates a D-START request that contains a CM-Logon Request message as the application data. This is preceded by a TP4 connection established between the airborne OSI End System and the IPS Gateway, and subsequently by a DTLS session established between the IPS Gateway and Ground IPS Host.
2. The ground CM application replies with D-START response that contains a CM-Logon Response. The Result attribute of this DS primitive contains the value Reject, which is an indication to terminate the application session.

Each application issues the dialogue service primitives to its local DS. [Figure 5-13](#) shows the message exchanges over the network between an OSI Aircraft and IPS Gateway and between the IPS Gateway and Ground IPS Host.

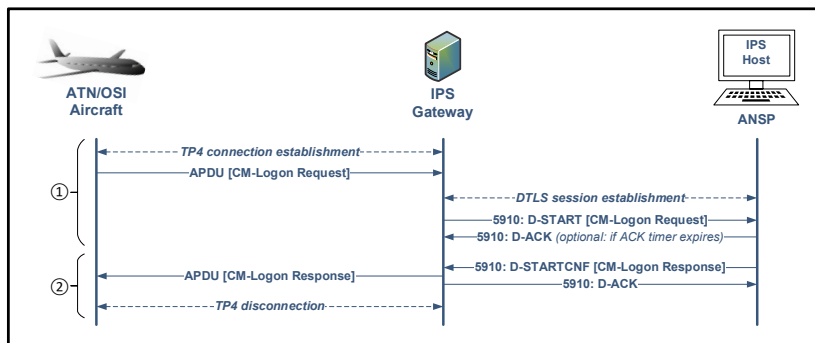

Figure 5-13 – CM Logon Message Exchanges between an OSI Aircraft and an IPS Host via an IPS Gateway

In this example:

- The airborne CM application issues a D-START request primitive to its local OSI Dialogue Service.
- The OSI Aircraft determines the OSI address (NSAP and TSEL) of the ground CM application. Since the ground application is located in an IPS network, the OSI address will point to the IPS Gateway.
- The OSI Aircraft establishes a TP4 connection with the IPS Gateway (shown by the dashed line).
- The OSI Aircraft sends an APDU containing a CM-Logon Request message to the IPS Gateway over the TP4 connection.
- The IPS Gateway converts the received APDU to a D-START indication primitive.
- The IPS Gateway determines the IPv6 address of the target Ground IPS Host, converts OSI addresses to IPS addresses, and establishes a DTLS session with that host (shown by the dashed line).

5.0 IPS GATEWAY FOR OSI

- The IPS Gateway converts the D-START indication primitive to a D-START ATNPKT that is sent to the Ground IPS Host.
- Optionally, to avoid re-transmission of the D-START ATNPKT, the Ground IPS Host sends a D-ACK ATNPKT to the IPS Gateway if an ACK timer expires prior to sending the D-STARTCNF ATNPKT.
- The Ground IPS Host converts the received D-START ATNPKT to a D-START indication primitive that is issued to the ground CM application.
- The ground CM application replies with a CM-Logon Response that is included in a D-START response primitive. The Result attribute of the primitive is set to value Rejected, which indicates that the application intends to close the session.
- The Ground IPS Host maps the D-START response primitive to a D-STARTCNF ATNPKT that is sent to the IPS Gateway. The Result field in the ATNPKT is set to Rejected.
- The IPS Gateway maps the received D-STARTCNF ATNPKT to a D-START confirmation primitive.
- The IPS Gateway sends a D-ACK ATNPKT to the Ground IPS Host to explicitly acknowledge receipt of the D-STARTCNF ATNPKT and prevent unnecessary retransmissions.
- The IPS Gateway inspects the CM application message and converts IPS addresses into OSI addresses.
- The IPS Gateway sends an APDU containing the CM-Logon Response to the OSI Aircraft over the TP4 connection
- The OSI Aircraft issues a D-START confirmation to the airborne CM application.
- The OSI Aircraft closes the TP4 connection with the IPS Gateway.

5.5.2 Ground-Initiated ATN Application Example

5.5.2.1 Ground ATN/OSI End System Communicating with an IPS Aircraft

This section describes a scenario for communication between two ATN applications that use the Dialogue Service, where communication is initiated by the ground. This example shows one possible exchange of CPDLC (port 5911) or ADS-C (port 5913) application messages.

The airborne application is running on an IPS Aircraft while the ground application is running on an OSI End System. The following DS Primitives are generated by the two applications:

1. The ground application starts the session with a D-START request. This is preceded by a TP4 connection established between the OSI End System and the IPS Gateway, and subsequently by a DTLS session established between the IPS Gateway and IPS Aircraft.
2. The airborne application replies with a D-START response
3. The ground application sends a D-DATA request. NOTE: There may be zero or more D-DATA requests generated by the either side of the conversation, but a single ground-initiated D-DATA request is shown for simplicity.
4. The ground application terminates the session with a D-END request

5.0 IPS GATEWAY FOR OSI

- The airborne application replies with a D-END response, after which the TP4 connection is disconnected.

Each application issues the dialogue service primitives to its local DS. [Figure 5-14](#) shows the message exchanges over the network between an IPS Aircraft and IPS Gateway and between the IPS Gateway and Ground OSI End System.

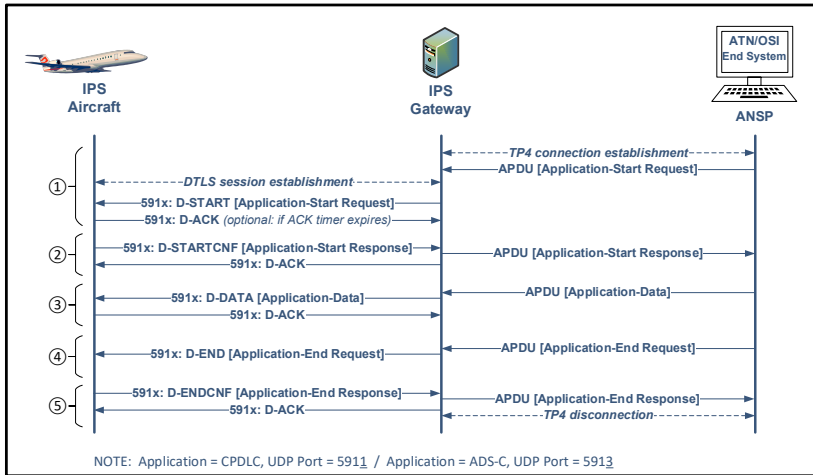

Figure 5-14 – Ground-initiated Application Message Exchanges between an IPS Aircraft and an ATN/OSI End System via an IPS Gateway

The following bullets provide a detailed description of the example scenario:

- A ground application issues a D-START primitive to the OSI Dialogue Service, which triggers the Ground OSI End System to establish a new TP4 connection with the IPS Gateway (shown as a dotted line).
- The Ground OSI End System sends an APDU containing the application start request to the IPS Gateway
- The IPS Gateway inspects the application message and converts OSI addresses into IPS addresses.
- A DTLS session is established between the IPS Aircraft and the IPS Gateway (shown as a dashed line).
- The IPS Gateway issues a D-START request primitive and maps it to a D-START ATNPKT that is sent to the IPS Aircraft.
- The IPS Aircraft maps the received D-START ATNPKT to a D-START indication primitive that is passed to the airborne application.
- Optionally, to avoid re-transmission of the D-START ATNPKT, the IPS Aircraft sends a D-ACK ATNPKT to the IPS Gateway if an ACK timer expires prior to sending the D-STARTCNF ATNPKT.
- The airborne application generates a D-START response primitive, which is converted to a D-STARTCNF ATNPKT and sent to the IPS Gateway.

5.0 IPS GATEWAY FOR OSI

- The IPS Gateway converts the received D-STARTCNF ATNPKT to a D-START response primitive that is sent to the Ground OSI End System over the TP4 connection
- The IPS Gateway sends a D-ACK ATNPKT to the IPS Aircraft to explicitly acknowledge receipt of the D-STARTCNF ATNPKT and prevent unnecessary retransmissions.
- Upon receipt of the message, the Ground OSI End System initiates the application session, converts the session information and APDU to a D-START indication primitive, which it forwards it to the ground application.
- The ground application generates a D-DATA request that is sent to the IPS Gateway as an APDU.
- The IPS Gateway converts the received D-DATA into a D-DATA ATNPKT that is sent to the IPS Aircraft.
- The IPS Aircraft maps the received D-DATA ATNPKT to a D-DATA primitive that is passed to the airborne application.
- The IPS Aircraft sends a D-ACK ATNPKT to the IPS Gateway to explicitly acknowledge receipt of the D-DATA ATNPKT and prevent unnecessary retransmissions.
- The ground application terminates the session with a D-END request that is sent to the IPS Gateway
- The IPS Gateway converts the received D-END request to a D-END ATNPKT that is sent to the IPS Aircraft.
- The IPS Aircraft maps the received D-END ATNPKT to a D-END indication primitive that is passed to the airborne application.
- The airborne application responds with a D-END response, which is converted to a D-ENDCNF ATNPKT and sent to the IPS Gateway.
- The IPS Gateway converts the received D-ENDCNF ATNPKT to a D-END response that is sent to the Ground OSI End System over the TP4 connection
- The IPS Gateway sends a D-ACK ATNPKT to the IPS Aircraft to explicitly acknowledge receipt of the D-ENDCNF ATNPKT and prevent unnecessary retransmissions.
- The IPS Gateway terminates the TP4 connection with the Ground OSI End System.

Note, that in [Figure 5-14](#), the D-ACK ATNPKT is used to explicitly acknowledge the reception of other ATNPKTs and to prevent possible message retransmissions. Depending on the timing, piggy-backed acknowledgements are also possible. It is also assumed that no packets are lost. In practice, depending on the network conditions ATNPKTs may be lost and this would trigger the retransmission of ATNPKTs. However, on the OSI side, transport reliability is guaranteed by the TP4 protocol.

5.5.2.2 Ground IPS Host Communicating with an ATN/OSI Aircraft

This section shows an example of communication between an OSI aircraft and a Ground IPS Host for ground-initiated ATN applications, such as CPDLC (port 5911) or ADS-C (port 5913).

5.0 IPS GATEWAY FOR OSI

The airborne application is running on an OSI Aircraft while the ground application is running on a Ground IPS Host. The following DS Primitives are generated by the two applications:

1. The ground application starts the session with a D-START request. This is preceded by a DTLS session established between the Ground IPS Host and the IPS Gateway, and subsequently by a TP4 connection established between the IPS Gateway and the airborne OSI End System.
2. The airborne application replies with a D-START response
3. The airborne and ground applications exchange application data messages using the D-DATA request primitive. NOTE: There may be zero or more D-DATA requests generated by the either side of the conversation, but one air-initiated and one ground-initiated D-DATA request is shown for simplicity.
4. The ground application terminates the session with a D-END request
5. The airborne application replies with a D-END response, after which the TP4 connection is disconnected.

Each application issues the dialogue service primitives to its local DS. [Figure 5-15](#) shows the resulting message exchanges over the network between an OSI Aircraft and IPS Gateway and between the IPS Gateway and Ground IPS Host.

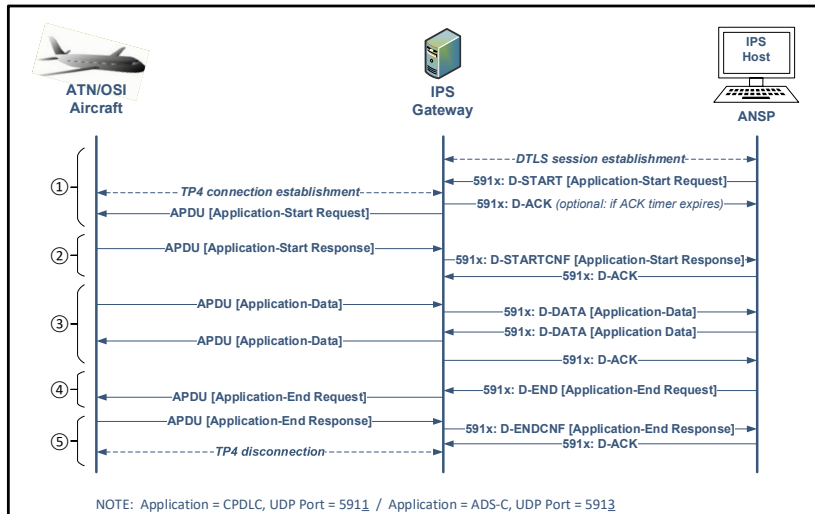

Figure 5-15 – Ground-initiated Application Message Exchanges between an OSI Aircraft and a Ground IPS Host via an IPS Gateway

The following bullets provide a detailed description of the example scenario:

- The Ground IPS Dialogue Service determines the IPv6 address of the correspondent airborne application. Since the airborne application is located in the OSI network, the address is the IPv6 address of the IPS Gateway.

5.0 IPS GATEWAY FOR OSI

- A ground IPS application issues a D-START request to its local IPS Dialogue Service, which triggers the Ground IPS Host to establish a DTLS session with the IPS Gateway (shown as a dashed line).
- The Ground IPS Host sends a D-START ATNPKT to the IPS Gateway.
- The IPS Gateway converts the received D-START ATNPKT to a D-START indication primitive, which is converted to a D-START request primitive at OSI side, triggering the IPS Gateway to establish a TP4 connection with the OSI aircraft.
- Optionally, to avoid re-transmission of the D-START ATNPKT, the IPS Gateway sends a D-ACK ATNPKT to the Ground IPS Host if an ACK timer expires prior to sending the D-STARTCNF ATNPKT.
- IPS Gateway sends an APDU containing the application start request to the OSI Aircraft.
- The OSI Aircraft maps the received message to a D-START indication that is passed to the airborne application.
- The airborne application replies with D-START response, which is sent over the TP4 connection as a downlink response message.
- IPS Gateway maps the received message to a D-START confirmation primitive (OSI side) and to a D-START response primitive (IPS side), which is converted to a D-STARTCNF ATNPKT and sent to the Ground IPS Host.
- The Ground IPS Host maps the D-STARTCNF ATNPKT to a D-START confirmation primitive that is delivered to the ground application. Note, that the received D-STARTCNF carries the acknowledgement for the sent D-START ATNPKT.
- The Ground IPS Host sends a D-ACK ATNPKT to the IPS Gateway to explicitly acknowledge receipt of the D-STARTCNF ATNPKT and prevent unnecessary retransmissions.
- The airborne OSI application generates a D-DATA request, which is sent to the IPS Gateway as an APDU.
- The IPS Gateway maps the received APDU to a D-DATA indication primitive (OSI side) and to a D-DATA request primitive (IPS side), which is converted to a D-DATA ATNPKT and sent to the Ground IPS Host.
- The Ground IPS Host maps the D-DATA ATNPKT to a D-DATA indication primitive, which is delivered to the ground application.
- The ground application replies immediately with a D-DATA request primitive, which is sent as D-DATA ATNPKT to the IPS Gateway. Note that this ATNPKT carries the acknowledgement for the previously received D-DATA ATNPKT; therefore, an explicit D-ACK ATNPKT is not required.
- The IPS Gateway maps the D-DATA ATNPKT to a D-DATA indication primitive (IPS side) and to a D-DATA request primitive (OSI side), which is sent to the OSI Aircraft as an APDU over the TP4 connection.
- The IPS Gateway sends a D-ACK ATNPKT to the Ground IPS Host to acknowledge receipt of the D-DATA ATNPKT. In this case, an explicit acknowledgement is sent since there are no other ATNPKTs waiting to be sent to the Ground IPS Host.

5.0 IPS GATEWAY FOR OSI

- The OSI aircraft maps the received APDU to a D-DATA indication primitive, which is passed to the airborne application.
- In the next step, the ground IPS application terminates the session with a D-END request primitive, which is converted to a D-END ATNPKT and sent to the IPS Gateway.
- The IPS Gateway maps the received D-END ATNPKT to a D-END indication (IPS side) primitive and to a D-END request (OSI side) that is sent to the OSI aircraft
- The OSI Aircraft maps the APDU to a D-END indication primitive, which is passed to the airborne application.
- The airborne application replies with a D-END confirmation primitive that is sent over the TP4 connection to the IPS Gateway
- The IPS Gateway maps the received message to a D-END confirmation primitive (OSI side) and to a D-END response primitive (IPS side), which is converted to a D-ENDCNF ATNPKT and sent to the Ground IPS Host.
- The IPS Gateway can now terminate the TP4 connection with the OSI Aircraft.
- The Ground IPS Host maps the received D-ENDCNF ATNPKT to a D-END confirmation primitive, which is delivered to the ground application.
- The Ground IPS Host sends a D-ACK ATNPKT to the IPS Gateway to explicitly acknowledge the reception of the D-ENDCNF ATNPKT.

**ATTACHMENT 1
LIST OF ACRONYMS****ATTACHMENT 1 LIST OF ACRONYMS**

A-G or A/G	Air-to-Ground
AAC	Aeronautical Administrative Communication
ACARS	Aircraft Communications Addressing and Reporting System
ACK	Acknowledgement
ACSP	Air-Ground Communications Service Provider
ADS	Automatic Dependent Surveillance
ADS-C	Automatic Dependent Surveillance-Contract
AEEC	Airlines Electronic Engineering Committee
AeroMACS	Aeronautical Mobile Airport Communications System
AFN	ATS Facilities Notification
AICF	ACARS to IPS DS Convergence Function
AN	Aircraft tail Number
ANSP	Air Navigation Service Provider
AOC	Airline or Aeronautical Operational Control
APDU	Application Protocol Data Unit
API	Application Programming Interface
App	Application
ASE	Application Service Entity
ATC	Air Traffic Control
ATM	Air Traffic Management
ATN	Aeronautical Telecommunication Network
ATNPKT	ATN Packet
ATS	Air Traffic Services
B1 / B2	Baseline 1 / Baseline 2
CDA	Current Data Authority
CLNP	Connectionless Network Protocol
CM	Context Management
cnf	Confirmation
COMM	COMMunications
COTP	Connection Oriented Transport Protocol
CPDLC	Controller Pilot Data Link Communications
CSP	Communication Service Provider
DGSS/IS	Datalink Ground Systems Standard and Interface Design Specification
DL	Downlink
DNS	Domain Name Service
DS	Dialogue Service
DSP	Data Link Service Provider
DTLS	Datagram Transport Layer Security
EC	European Commission

**ATTACHMENT 1
LIST OF ACRONYMS**

EU	European Union
FAA	Federal Aviation Administration
FANS	Future Air Navigation System
FI	Flight Identifier
FlightID	Flight Identifier
G-G or G/G	Ground-to-Ground
GANP	Global Air Navigation Plan
GOLD	Global Operational Data Link
GW	Gateway
HFN	High Frequency Next
IATA	International Air Transport Association
ICAO	International Civil Aviation Organization
ID	Identifier
IDRP	Inter Domain Routing Protocol
IEC	International Electrotechnical Commission
IF	Interface
ind	Indication
IP	Internet Protocol
IPS	Internet Protocol Suite
IPS DS	Internet Protocol Suite Dialogue Service
IPS GW	Internet Protocol Suite Gateway
IPv4 / IPv6	Internet Protocol Version 4 or Version 6
ISO	International Standards Organization
LDACS	L Band Digital Aviation Communication System
MA	Message Assurance
MAS	Message Assurance Message
MASPS	Minimum Aviation System Performance Standards
MATIP	Mapping of Airline Traffic over Internet Protocol
NDA	Next Data Authority
NextGen	Next Generation Air Transportation System
NSAP	Network Service Access Point
OSI	Open System Interconnection
PDU	Protocol Data Unit
QoS	Quality of Service
req	Request
rsp	Response
Satcom	Satellite Communications
SB-Safety	Swift Broadband-Safety
SBB	Swift Broadband
SDO	Standards Development Organization
SESAR	Single European Sky Air Traffic Management (ATM) Research

ATTACHMENT 1
LIST OF ACRONYMS

SESAR JU	SESAR Joint Undertaking
SMI	Standard Message Identifier
SNL	Simple Name Lookup
SPR	Safety and Performance Requirement
SVC	Service (message)
TCP	Transmission Control Protocol
TEI	Text Element Identifier
TLS	Transport Layer Security
TP	Transmission Path
TP4	Transport Protocol 4
TSEL	Transport Selector
UDP	User Datagram Protocol
UL	Uplink
ULCS	Upper Layer Communication Services
US	United States
VDL	VHF Digital Link
VDLM2	VHF Digital Link Mode 2
VHF	Very High Frequency
WG	Working Group

ATTACHMENT 2
GLOSSARY

ATTACHMENT 2 GLOSSARY

AAC – Aeronautical Administrative Communications

Communication used by aeronautical operating agencies related to the business aspects of operating their flights and transport services. This communication is used for a variety of purposes, such as flight and ground transportation, bookings, deployment of crew and aircraft or any other logistical purposes that maintain or enhance the efficiency of over-all flight operation. [Source: ICAO Doc. 9705]

ACARS – Aircraft Communications Addressing and Reporting System

A digital datalink network providing connectivity between aircraft and ground end systems (command and control, air traffic control).

Access Network

A network that is characterized by a specific access technology. [Source: ICAO Doc. 9896]

ACSP – Air-Ground Communication Service Provider

Service provider that provides air-ground communication services via an access network.

Administrative Domain

An administrative entity in the ATN/IPS. An administrative domain can be an individual State, a group of States, an aeronautical industry organization (e.g., an air-ground service provider), or an air navigation service provider (ANSP) that manages ATN/IPS network resources and services. From a routing perspective, an administrative domain includes one or more autonomous systems. [Source: ICAO Doc. 9896]

ADS-C – Automatic Dependent Surveillance-Contract

A means by which the terms of an ADS-C agreement will be exchanged between the ground system and the aircraft, via a data link, specifying under what conditions ADS-C reports would be initiated, and what data would be contained in the reports. [Source: ICAO Annex 10, Volume III]

Air-Ground Access Network

Access network that provides air-ground communication services.

Air-Ground Datalink

Refer to the definition for Air-Ground Access Network.

Airborne IPS Host

Airborne instantiation of an IPS Host.

Airborne IPS System

The collection of airborne components and functions that provide IPS services.

**ATTACHMENT 2
GLOSSARY**

AOC – Aeronautical Operational Control

Communication required for the exercise of authority over the initiation, continuation, diversion or termination of flight for safety, regularity and efficiency reasons. [Source: ICAO Annex 10, Part III]

AOC – Airline Operational Control

Operational messages used between aircraft and airline dispatch centers or, by extension, the DoD to support flight operations. This includes, but is not limited to, flight planning, flight following, and the distribution of information to flights and affected personnel.

Application

The ultimate use of an information system, as distinguished from the system itself. [Source: ICAO Doc. 9880].

ATC – Air Traffic Control

A service operated by an appropriate authority to promote the safe, orderly, and expeditious flow of air traffic. [Source: FAA Pilot-Controller Glossary]

ATC – Air Traffic Control Service

A service provided for the purpose of: a) preventing collisions between aircraft and on the maneuvering area between aircraft and obstructions; and b) expediting and maintaining an orderly flow of traffic. [Source: ICAO Doc. 10037]

ATM – Air Traffic Management

The dynamic, integrated management of air traffic and airspace (including air traffic services, airspace management and air traffic flow management) — safely, economically and efficiently — through the provision of facilities and seamless services in collaboration with all parties and involving airborne and ground-based functions. [Source: ICAO Doc. 10037]

ATN – Aeronautical Telecommunications Network

A global internetwork architecture that allows ground, air-ground, and avionic data subnetworks to exchange digital data for the safety of air navigation and for the regular, efficient and economic operation of air traffic services. [Source: ICAO Annex 10, Part III]

ATN/IPS

The set of technical provisions and standards that define the architecture and operation of Internet Protocol-based networking services. Also referred to as IPS.

ATN/IPS Network / System

Internetwork consisting of ATN/IPS nodes and networks operating in a multinational environment in support of Air Traffic Services (ATS) as well as aeronautical industry service communication such as Aeronautical Operational Control (AOC) and Aeronautical Administrative Communications (AAC).

**ATTACHMENT 2
GLOSSARY**

ATS – Air Traffic Services

A generic term meaning variously, flight information service, alerting service, air traffic advisory service, air traffic control service (area control service, approach control service or aerodrome control service) and aerodrome flight information service. [Source: ICAO Annex 11]

CM Application – Context Management Application

An ATN application that provides a logon service allowing initial aircraft introduction into the ATN and a directory of all other data link applications on the aircraft. It also includes functionality to forward between ATS units. [Source: ICAO Doc. 9880]

CPDLC – Controller-Pilot Data Link Communications

A means of communication between controller and pilot, using data link for ATC communications. [Source: ICAO Doc. 10037]

CPDLC Application – Controller-Pilot Data Link Communications Application

An ATN application that provides a means of data communication between controlling, receiving or downstream ATS units and the aircraft, using air-ground and ground-ground subnetworks, and which is consistent with the ICAO phraseology for the current ATC voice communication. [Source: ICAO Doc. 9880]

CSP – Communication Service Provider

Any public or private entity providing communication services for general air traffic.

Downlink

A unit of data sent from an aircraft to a ground-based system.

DS – Dialogue Service

An interface between the ATN applications and the ATN/OSI or ATN/IPS upper layer protocols via the control function.

End System

A system that contains the OSI seven layers and contains one or more end-user application processes. [Source: ICAO Doc. 9880]

FANS-1/A – Future Aircraft Navigation System 1/A

A set of operational capabilities centered around direct datalink communications between the flight crew and air traffic control. Operators benefit from FANS-1/A in oceanic and remote airspace around the world.

FMS – Flight Management System

A computer system that uses a large database to allow routes to be preprogrammed and fed into the system by a means of a data loader. The system is constantly updated with respect to position by reference to designated sensors. The sophisticated program and its associated database ensure that the most appropriate aids are automatically selected during the information update cycle. The flight management system is interfaced/coupled to cockpit displays to provide the flight crew situational awareness and/or an autopilot.

**ATTACHMENT 2
GLOSSARY**

Ground IPS Host

Ground instantiation of an IPS Host.

Ground IPS Node

Ground instantiation of an IPS Node.

Ground IPS Router

A ground device that is used to support ATN/IPS packet forwarding in both air-ground and ground-ground environments. [Source: RTCA DO-379A and EUROCAE ED-262A]

Ground IPS System

The collection of ground components and functions that provide IPS services.

Infrastructure

This is a general term corresponding to the communication systems that support the application sets. It consists of the network and subnetwork functions.

Integrity

Safety usage – Qualitative or quantitative attribute of a system or an item indicating that it can be relied upon to work correctly. It is sometimes expressed in terms of the probability of not meeting the work correctly criteria.

Security usage – Property whereby data or an asset has not been modified in an unauthorized manner since it was created, transmitted, or stored.

IPS (aka IPS for Safety Services)

Refer to the definition for ATN/IPS.

IPS Gateway

A system that establishes and maintains an operational association between two heterogeneous peer communicating systems, where one system is an IPS Node and the other is a different communication system, such as an OSI End System or an ACARS Host. Note: An IPS Gateway exchanges IPv6 packets with the IPS Node, which may be an Airborne IPS System or a Ground IPS Host.

IPS Host

The originator or terminator of IP packets in the IPS System. IPS Hosts do not route IP packets that are not addressed to it. [Source: RTCA DO-379A and EUROCAE ED-262A]

IPS Node

A device that implements IPv6. There are two types of IPS nodes: an IPS Host and an IPS Router. Note: An IPS Gateway could be considered an IPS Node.

IPS Router

A node that forwards Internet protocol (IP) packets not explicitly addressed to itself. A router manages the relaying and routing of data while in transit from an originating IPS Host to a destination IPS Host. [Source: ICAO Doc. 9896]

**ATTACHMENT 2
GLOSSARY**

IPS System

The IPS System is the all-encompassing aviation internet that provides data transport, networking, routing, addressing, naming, mobility, multilink and information security functions to the aviation services. The IPS System includes the Layer 3 and Layer 4 functions of the ISO/IEC 7498-1 OSI 7-layer Reference Model. The IPS System does not include the underlying subnetwork functions that provide connectivity or the applications. [Source: RTCA DO-379A and EUROCAE ED-262A]

MASPS – Minimum Aviation System Performance Standards

Specifies characteristics of systems intended for operational use within a defined airspace. Where the systems are global in nature, the system may have international applications that are taken into consideration. The MASPS describes the system (subsystems / functions) and provides information needed to understand the rationale for system characteristics, operational goals, requirements and typical applications. Definitions and assumptions essential to proper understanding of the MASPS are provided as well as minimum system test procedures to verify system performance compliance (e.g., end-to-end performance verification). [Source: RTCA]

Multilink

Ability to use all available air-ground access networks in order to provide the specified performance.

Network

A group of two or more devices (nodes) that communicate using a common set of communication protocols.

Network Layer

Protocol layer based on Internet Protocol (IP) ensuring global routing over interconnected packet-switched communication networks.

Physical and Link Layers

Functions within the subnetworks that handle the physical interface with the transmission medium (i.e., radio links).

QoS – Quality of Service

A framework where the overall performance of an application or a computer network is stated. Some examples of parameters are: Integrity, Availability, Delay, Continuity, bit rate, throughput, delay, etc.

Satcom – Satellite Communications

Communication service providing data, voice, and fax transmission via satellite. Allows aircraft to communicate in BLOS areas.

SESAR – Single European Sky ATM Research

European air traffic control infrastructure modernization program. SESAR aims at developing the new generation ATM system capable of ensuring the safety and fluidity of air transport worldwide over the next 30 years.

**ATTACHMENT 2
GLOSSARY**

Subnetwork

An actual implementation of a data network that employs a homogeneous protocol and addressing plan and is under control of a single authority. [ICAO Doc. 9705]

Transport Layer

Protocol layer used to provide reliable or unreliable communication services over the IPS System. Those include TCP for reliable transport services and UDP that is used to provide best effort service.

Uplink

A unit of data sent from a ground-based system to an aircraft.

VDL – VHF Digital Link

A constituent mobile subnetwork of the aeronautical telecommunication network (ATN), operating in the aeronautical mobile VHF frequency band. In addition, the VDL may provide non-ATN functions such as, for instance, digitized voice. [Source; ICAO Annex 10, Volume I]

VDLM2 – VHF Digital Link Mode 2

A datalink-only service designed to digitize VHF and improve the speed of the VHF link. VDLM2 is intended for use within the US and Europe as a datalink solution for ATC functions. VDLM2 provides a 31.5 kbps channel rate.